



KOMFORT EC SBE 250 L S21

Heat and humidity recovery air handling units

- Power of electrical preheater: 1400
- Maximum airflow: 390
- Sound pressure level LpA at 3 m: 35
- Heat exchanger type: Counter flow
- Extract filter: G4
- Supply filter: G4 (option: F7)
- Sound insulation
- Motor type: EC
- Bypass: Auto
- Reheater: Optional
- Preheater: Built-in
- BMS protocol: ModBus
- Control: Smartphone
- Casing material: Coated steel
- Humidity sensor: Optional
- CO2 sensor: Optional
- VOC sensor: Optional
- PM2.5 sensor: Optional

	Unit of measurement	KOMFORT EC SBE 250 L S21
Connected air duct size	mm	160
Speed	-	1
Phases	-	1
Minimum supply voltage	V	230
Maximum supply voltage	V	230
Power supply frequency	Hz	50/60
Rated power	W	180
Power of electrical preheater	W	1400
Unit current	A	7.46
Maximum airflow	m ³ /h	390
Sound pressure level LpA at 3 m	dB(A)	35
Heat recovery efficiency, max	%	95
Heat exchanger type	-	Counter flow
Heat exchanger material	-	Polystyrene
Weight	kg	66
Extract filter	-	G4
Supply filter	-	G4 (option: F7)
Transported air temperature (max)	°C	40
Transported air temperature (min)	°C	-25

Ambient air temperature min	°C	1
Ambient air temperature max	°C	40
Ambient air humidity max	%	60
Ingress protection rating	-	IP20
Ingress protection rating of the drive	-	IP44

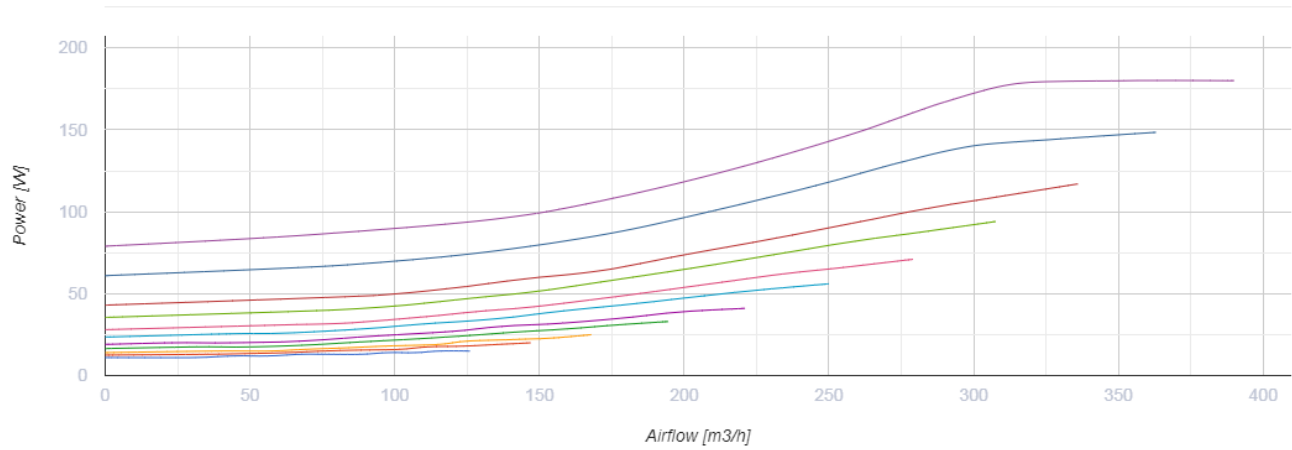
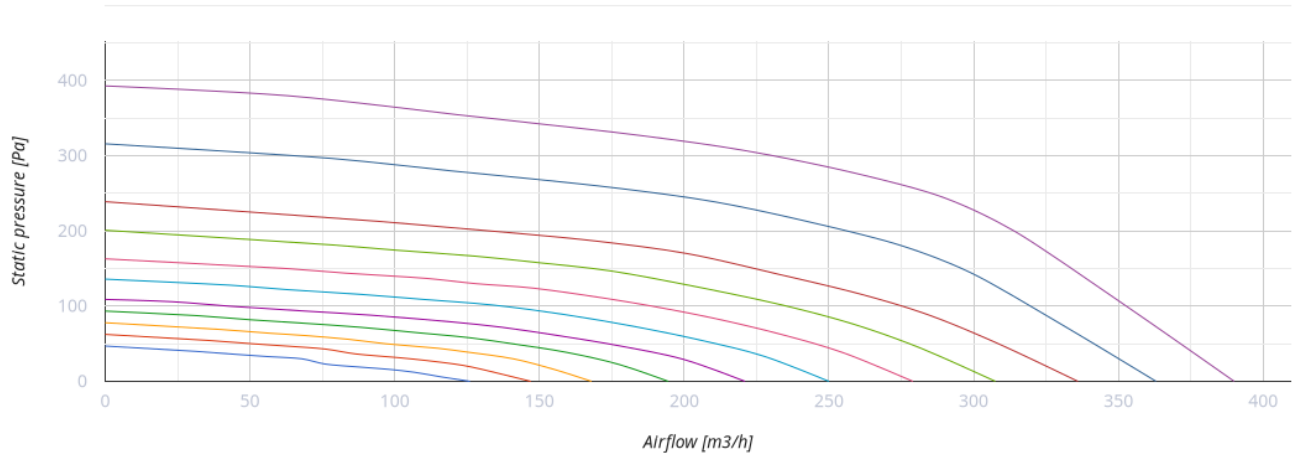

Dimensions

ØD	B	H	L
160	560	970	560



Ecodesign

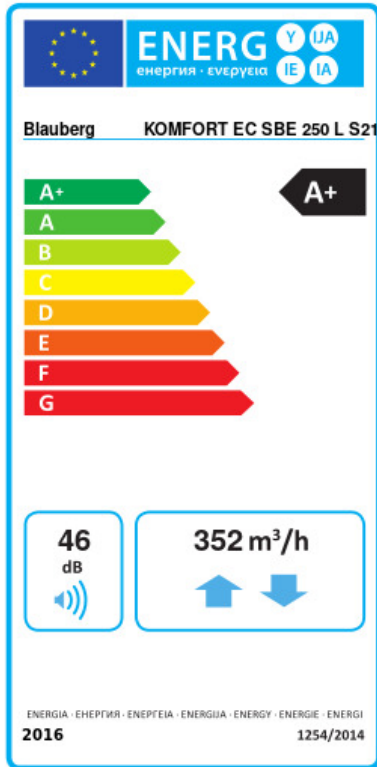



Trademark	Blauberg					
Model	KOMFORT EC SBE 250 L S21					
Specific energy consumption (SEC) (kWh/(m ² /a))	Cold		Average		Warm	
	82.5	A+	43	A+	17.8	E
Type of ventilation unit	Bidirectional					
Type of drive installed	Variable speed					
Type of heat recovery system	Recuperative					
Thermal efficiency of heat recovery (%)	90					
Maximum flow rate (m ³ /h)	352					
Electric power input (W)	180					
Reference flow rate (m ³ /s)	0.068					
Reference pressure difference (Pa)	50					
Specific power input (SPI) (W/(m ³ /h))	0.261					
Control typology	Local demand control					
Maximum internal leakage rates (%)	2.7					
Maximum external leakage rates (%)	2.7					
Declared typology	RVU BVU					
Sound power level (dB(A))	46					
The annual electricity consumption (AEC) (kWh/a)	Cold		Average		Warm	
	720		183		138	
The annual heating saved (AHS) (kWh/a)	Cold		Average		Warm	
	9181		4693		2122	



Accessories

Other accessories



Name	Photo	Description
FP 340x170x48 G4		G4 panel filter

FP 340x170x48 F7		F7 panel filter
FP 500x170x48 G4		G4 panel filter

Other accessories



Name	Photo	Description
S22		Control panels
S22 Wi-Fi		Control panels
S25		LCD control panel

Other accessories

Name	Photo	Description
FS2		Humidity sensor
CD-1		CO2 sensors
CD-2		CO2 sensors

Other accessories

Name	Photo	Description
ENH 160-0.8-1 S21 V.2		Duct heater for supply air reheating
ENH 160-1.2-1 S21 V.2		Duct heater for supply air reheating

ENH 160-1.7-1 S21 V.2		Duct heater for supply air reheating
ENH 160-2.0-1 S21 V.2		Duct heater for supply air reheating

Other accessories

Name	Photo	Description
VKA 160		Air dampers for round ducts

Other accessories

Name	Photo	Description
Belimo TF230		Electric actuators