



# KOMFORT EC SB 250-E R S21

Heat and humidity recovery air handling units

- Maximum airflow: 390
- Sound pressure level LpA at 3 m: 35
- Heat exchanger type: Counter flow
- Extract filter: G4
- Supply filter: G4 (option: F7)
- Sound insulation
- Motor type: EC
- Enthalpy heat exchanger
- Bypass: Auto
- Reheater: Optional
- Preheater: Optional
- BMS protocol: ModBus
- Control: Smartphone
- Casing material: Coated steel
- Humidity sensor: Optional
- CO2 sensor: Optional
- VOC sensor: Optional
- PM2.5 sensor: Optional

	Unit of measurement	KOMFORT EC SB 250-E R S21
Connected air duct size	mm	160
Speed	-	1
Phases	-	1
Minimum supply voltage	V	230
Maximum supply voltage	V	230
Power supply frequency	Hz	50/60
Rated power	W	180
Unit current	A	1.37
Maximum airflow	m <sup>3</sup> /h	390
Sound pressure level LpA at 3 m	dB(A)	35
Heat recovery efficiency, max	%	90
Heat exchanger type	-	Counter flow
Heat exchanger material	-	Enthalpy
Weight	kg	66
Extract filter	-	G4
Supply filter	-	G4 (option: F7)
Transported air temperature (max)	°C	40
Transported air temperature (min)	°C	-25
Ambient air temperature min	°C	1

Ambient air temperature max	°C	40
Ambient air humidity max	%	60
Ingress protection rating	-	IP20
Ingress protection rating of the drive	-	IP44

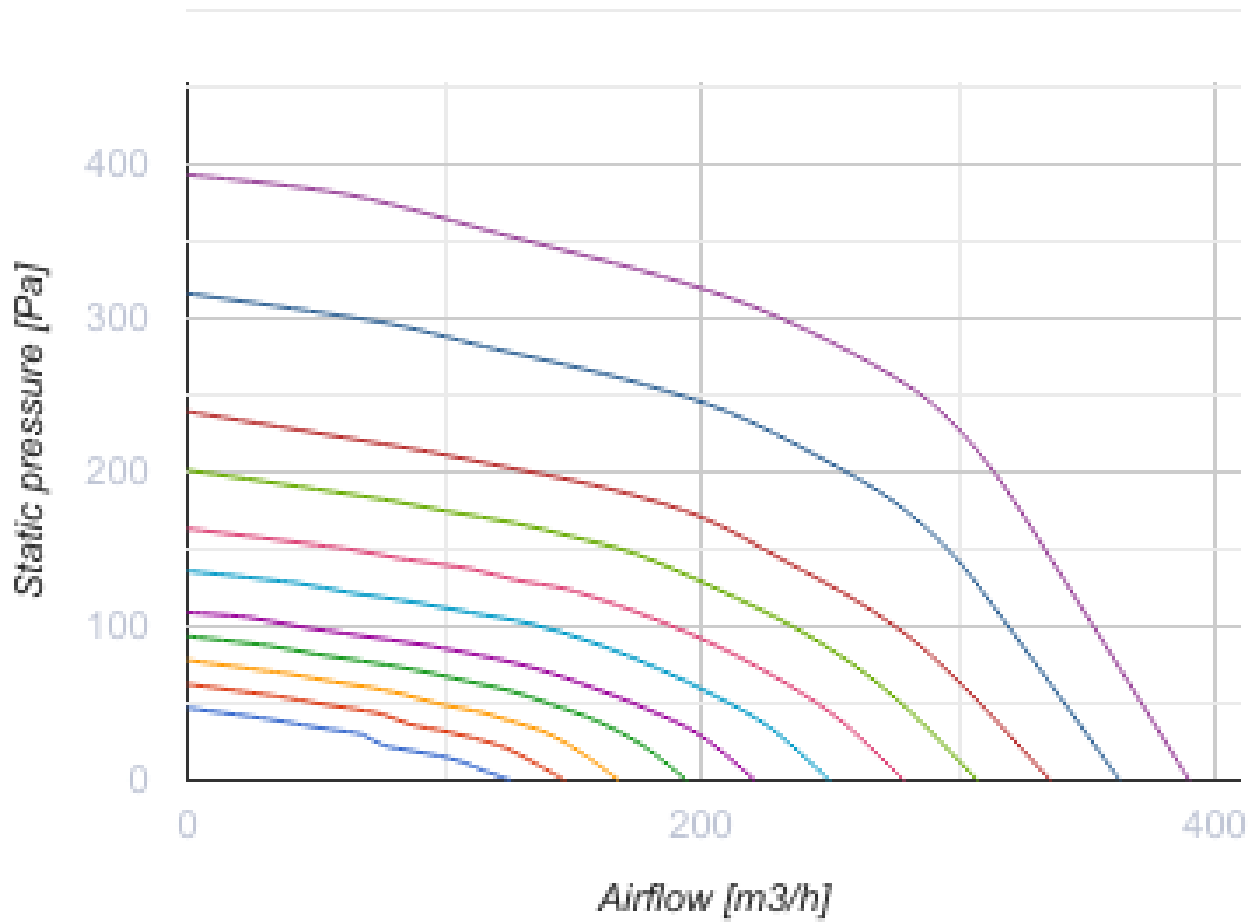

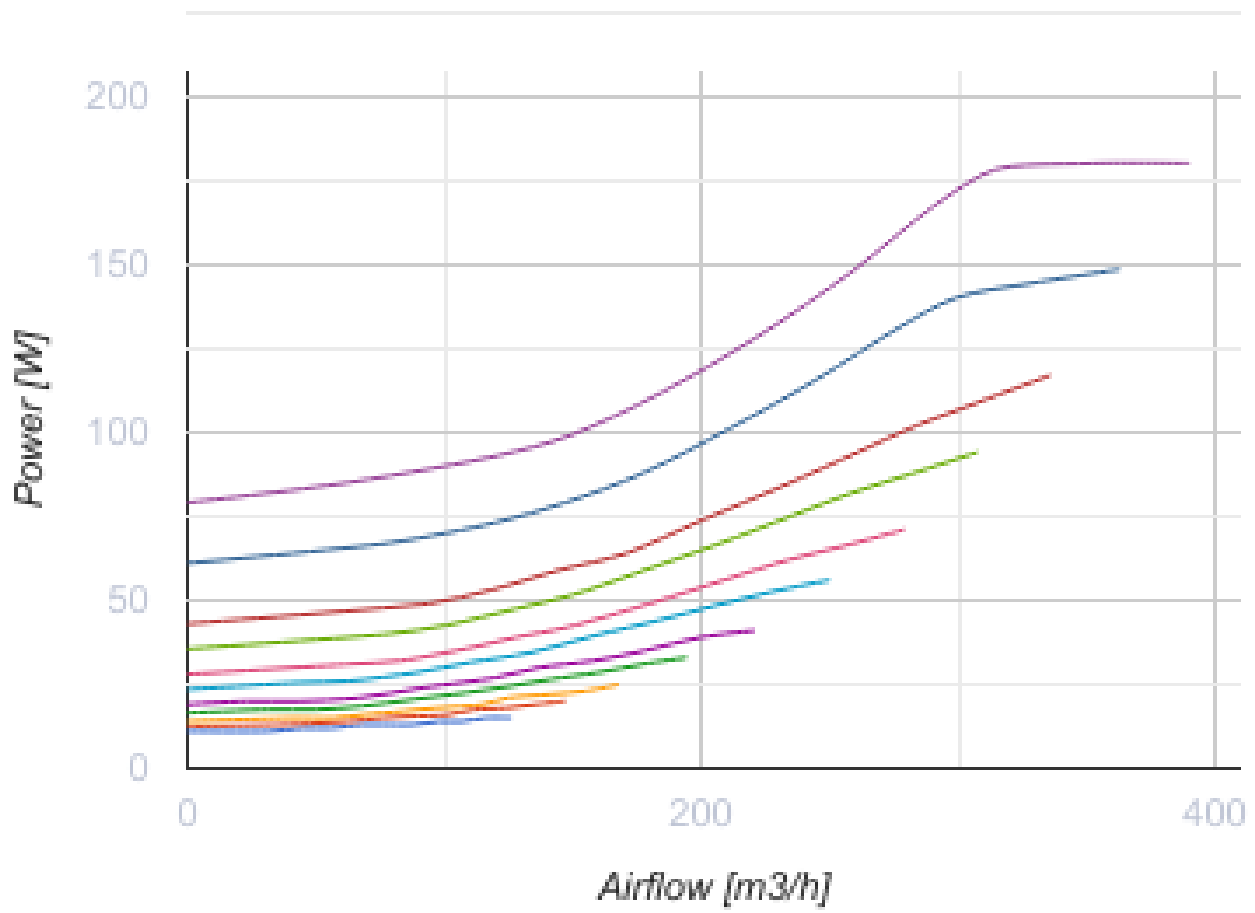

## Dimensions

ØD	B	H	L
160	560	970	560



## Ecodesign

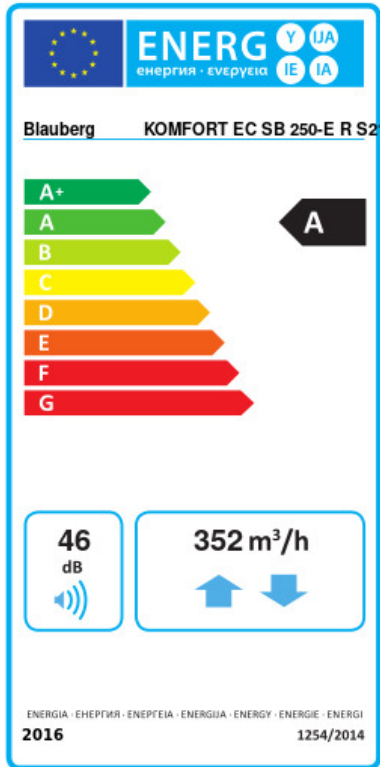



Trademark	Blauberg					
Model	KOMFORT EC SB 250-E R S21					
Specific energy consumption (SEC) (kWh/(m <sup>2</sup> /a))	Cold		Average		Warm	
	78.5	A+	41	A	16.8	E
Type of ventilation unit	Bidirectional					
Type of drive installed	Variable speed					
Type of heat recovery system	Recuperative					
Thermal efficiency of heat recovery (%)	80					
Maximum flow rate (m <sup>3</sup> /h)	352					
Electric power input (W)	180					
Reference flow rate (m <sup>3</sup> /s)	0.068					
Reference pressure difference (Pa)	50					
Specific power input (SPI) (W/(m <sup>3</sup> /h))	0.261					
Control typology	Local demand control					
Maximum internal leakage rates (%)	2.7					
Maximum external leakage rates (%)	2.7					
Declared typology	RVU BVU					
Sound power level (dB(A))	46					
The annual electricity consumption (AEC) (kWh/a)	Cold		Average		Warm	
	720		183		138	
The annual heating saved (AHS) (kWh/a)	Cold		Average		Warm	
	8776		4486		2029	



## Accessories

### Other accessories



Name	Photo	Description
FP 340x170x48 G4		G4 panel filter

FP 340x170x48 F7		F7 panel filter
FP 500x170x48 G4		G4 panel filter

### Other accessories



Name	Photo	Description
<a href="#">S22</a>		Control panels
<a href="#">S22 Wi-Fi</a>		Control panels
<a href="#">S25</a>		LCD control panel

### Other accessories

Name	Photo	Description
<a href="#">FS2</a>		Humidity sensor
<a href="#">CD-1</a>		CO2 sensors
<a href="#">CD-2</a>		CO2 sensors

### Other accessories

Name	Photo	Description
<a href="#">ENH 160-0.8-1 S21 V.2</a>		Duct heater for supply air reheating
<a href="#">ENH 160-1.2-1 S21 V.2</a>		Duct heater for supply air reheating

<a href="#">ENH 160-1.7-1 S21 V.2</a>		Duct heater for supply air reheating
<a href="#">ENH 160-2.0-1 S21 V.2</a>		Duct heater for supply air reheating

### Other accessories

Name	Photo	Description
<a href="#">VKA 160</a>		Air dampers for round ducts

### Other accessories

Name	Photo	Description
<a href="#">Belimo TF230</a>		Electric actuators