



KOMFORT EC SB 160-E S14

Heat and humidity recovery air handling units

- Maximum airflow: 200
- Sound pressure level LpA at 3 m: 24
- Heat exchanger type: Counter flow
- Extract filter: G4
- Supply filter: F7 (option: G4), F7 (опция: G4)
- Sound insulation
- Motor type: EC
- Enthalpy heat exchanger
- Bypass: Manual
- Control: Wired control panel
- Casing material: Coated steel
- Humidity sensor: Optional
- CO2 sensor: Optional

	Unit of measurement	KOMFORT EC SB 160-E S14
Connected air duct size	mm	125
Speed	-	1
Phases	-	1
Minimum supply voltage	V	230
Maximum supply voltage	V	230
Power supply frequency	Hz	50/60
Rated power	W	57
Unit current	A	0.5
Maximum airflow	m ³ /h	200
Sound pressure level LpA at 3 m	dB(A)	24
Heat recovery efficiency, max	%	92
Heat exchanger type	-	Counter flow
Heat exchanger material	-	Enthalpy
Weight	kg	36
Extract filter	-	G4
Supply filter	-	F7 (option: G4), F7 (опция: G4)
Transported air temperature (max)	°C	40
Transported air temperature (min)	°C	-25
Ambient air temperature min	°C	1
Ambient air temperature max	°C	40
Ambient air humidity max	%	60

Ingress protection rating	-	IP20
Ingress protection rating of the drive	-	IP44

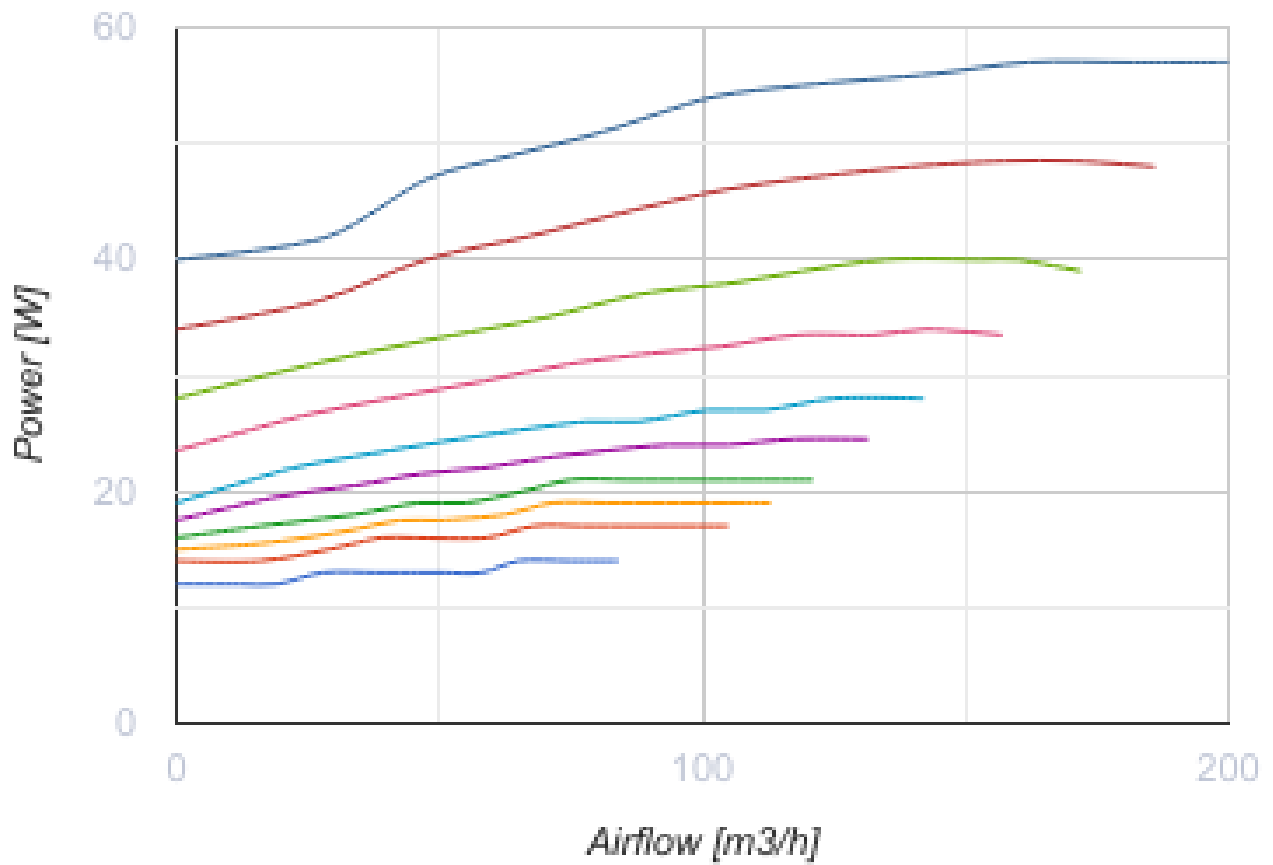

Dimensions

D	B	H	L
125	330	580	600



Ecodesign

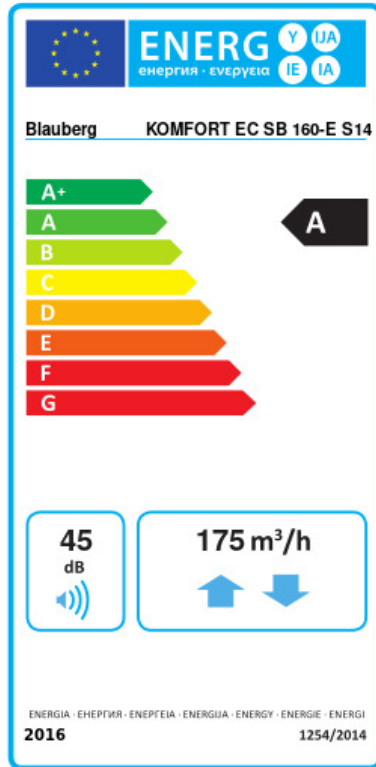

Trademark	Blauberg		
Model	KOMFORT EC SB 160-E S14		
Specific energy consumption (SEC) (kWh/(m²/a))	Cold	Average	Warm
	78.7	A+	41.4 A 17.3 E
Type of ventilation unit	Bidirectional		
Type of drive installed	Variable speed		
Type of heat recovery system	Recuperative		
Thermal efficiency of heat recovery (%)	79		
Maximum flow rate (m³/h)	175		
Electric power input (W)	57		
Reference flow rate (m³/s)	0.036		
Reference pressure difference (Pa)	50		
Specific power input (SPI) (W/(m³/h))	0.215		
Control typology	Local demand control		
Maximum internal leakage rates (%)	2.7		
Maximum external leakage rates (%)	2.7		
Sound power level (dB(A))	45		
Declared typology	RVU BVU		
The annual electricity consumption (AEC) (kWh/a)	Cold	Average	Warm
	696	159	114
The annual heating saved (AHS) (kWh/a)	Cold	Average	Warm
	8736	4466	2019

Accessories

Other accessories



Name	Photo	Description
FP 285x195x10 G4		G4 panel filter

FP 285x195x10 F7		F7 panel filter
------------------	---	-----------------

Humidity sensors

Name	Photo	Description
FS2		Humidity sensor

CO2 sensors

Name	Photo	Description
CD-1		CO2 sensors
CD-2		CO2 sensors

Other accessories

Name	Photo	Description
DAH 251-13		Kitchen exhaust hood

For round ducts

Name	Photo	Description
VKA 125		Air dampers for round ducts

Electric actuators

Name	Photo	Description
Belimo TF230		Electric actuators