

KOMFORT EC DBW 3000 S21 DTV

Suspended heat recovery air handling units

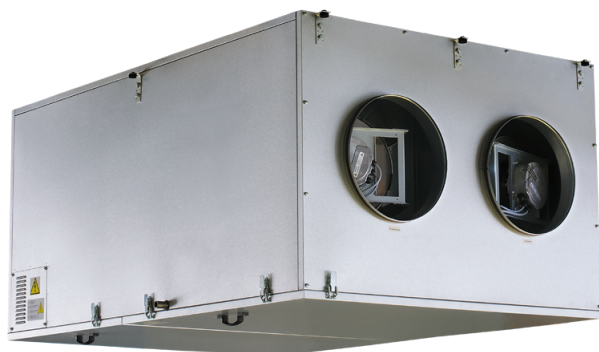

- Maximum airflow: 4300
- Sound pressure level LpA at 3 m: 46
- Heat exchanger type: Cross flow
- Extract filter: G4
- Supply filter: G4 (F7 option)
- Sound insulation
- Motor type: EC
- Bypass: Auto
- Reheater: Water
- BMS protocol: ModBus
- Control: Smartphone
- Casing material: Galvanized steel
- Humidity sensor: Optional
- CO2 sensor: Optional
- VOC sensor: Optional
- PM2.5 sensor: Optional

	Unit of measurement	KOMFORT EC DBW 3000 S21 DTV
Connected air duct size	mm	400
Speed	-	1
Phases	-	3
Minimum supply voltage	V	400
Maximum supply voltage	V	400
Power supply frequency	Hz	50/60
Rated power	W	2226
Unit current	A	3.5
Maximum airflow	m ³ /h	4300
Sound pressure level LpA at 3 m	dB(A)	46
Heat recovery efficiency, max	%	72
Heat exchanger type	-	Cross flow
Heat exchanger material	-	Aluminum
Weight	kg	268
Extract filter	-	G4
Supply filter	-	G4 (F7 option)
Transported air temperature (max)	°C	40
Transported air temperature (min)	°C	-25

Ambient air temperature min	°C	1
Ambient air temperature max	°C	40
Ambient air humidity max	%	60
Ingress protection rating	-	IP22
Ingress protection rating of the drive	-	IP44

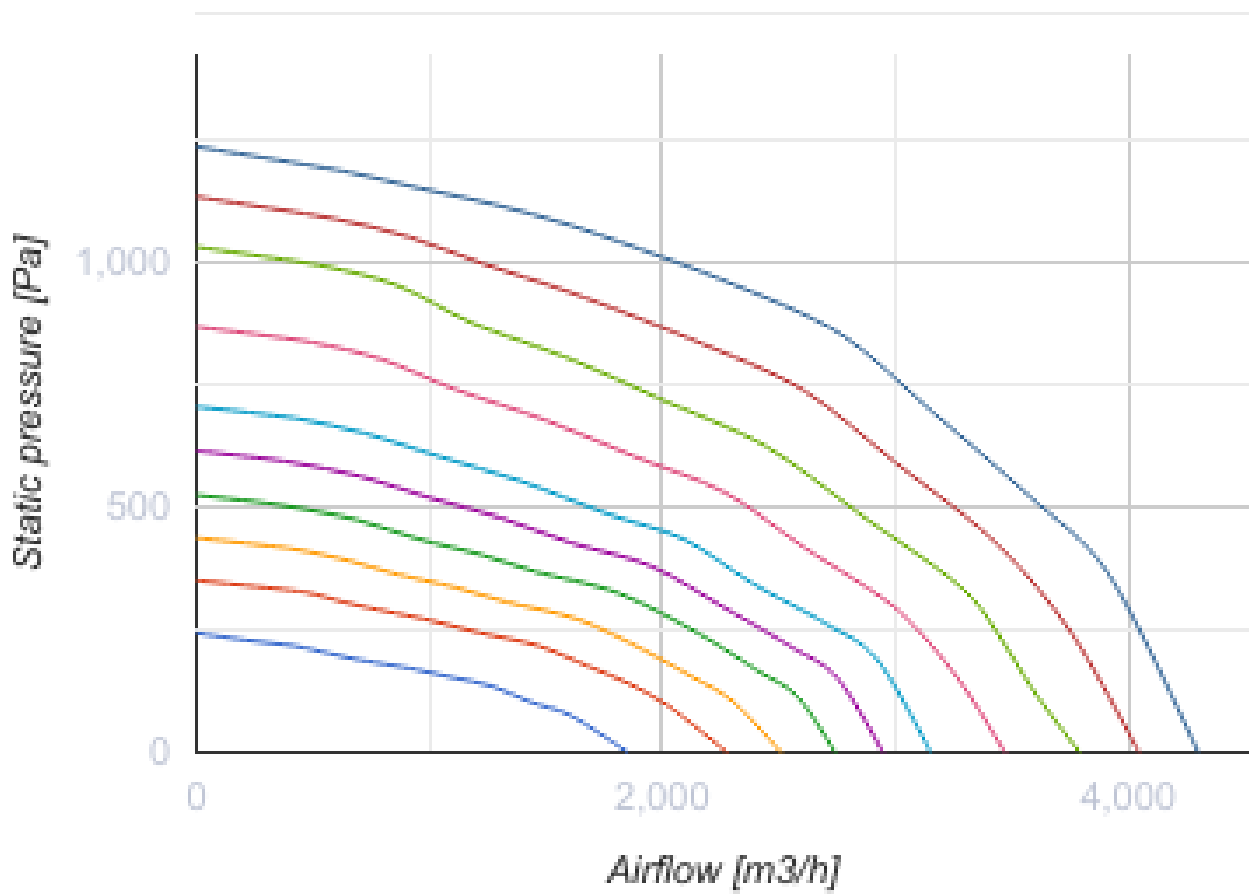

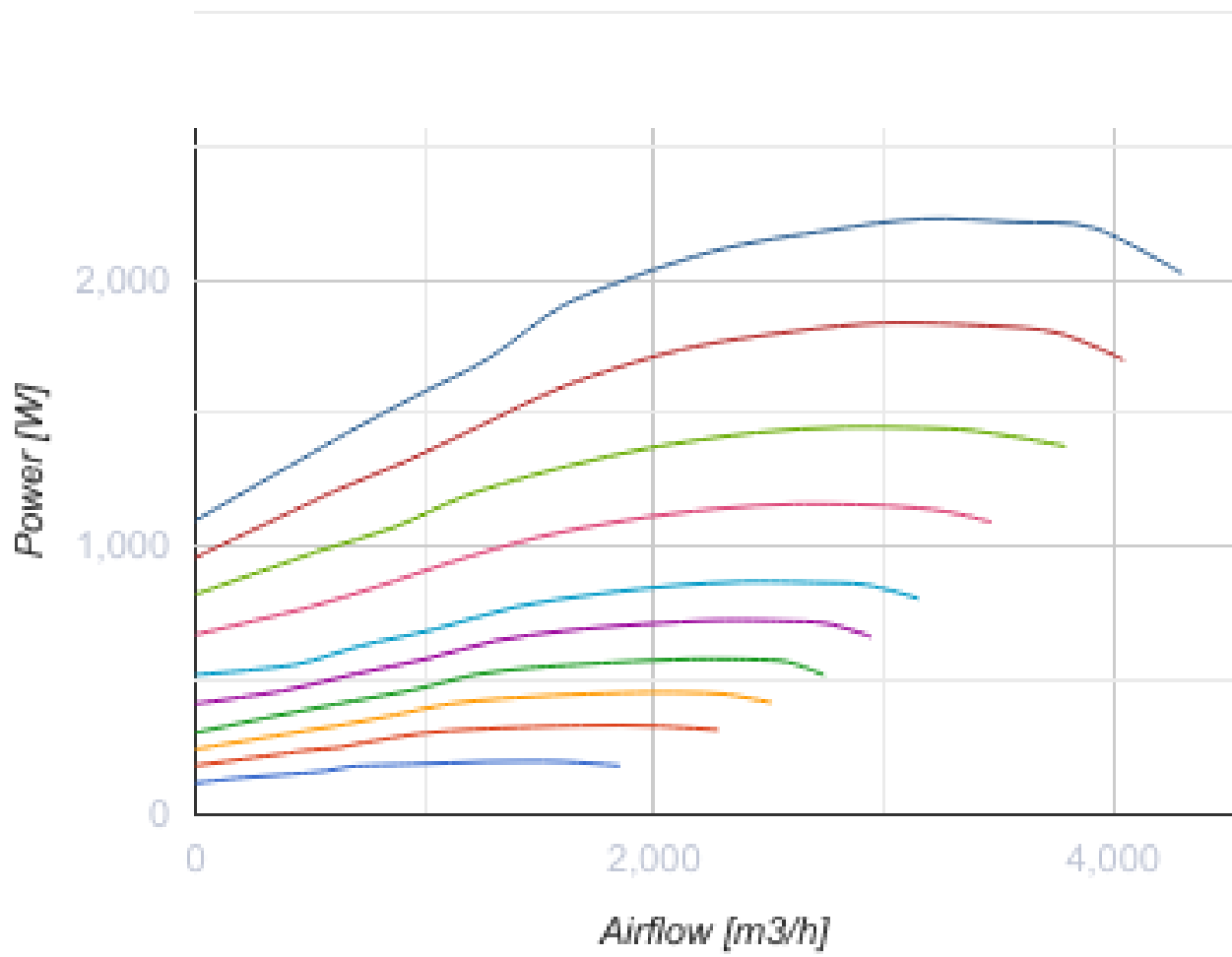

Dimensions

Ø D	B	H	L	L1
400	1265	830	1835	1888

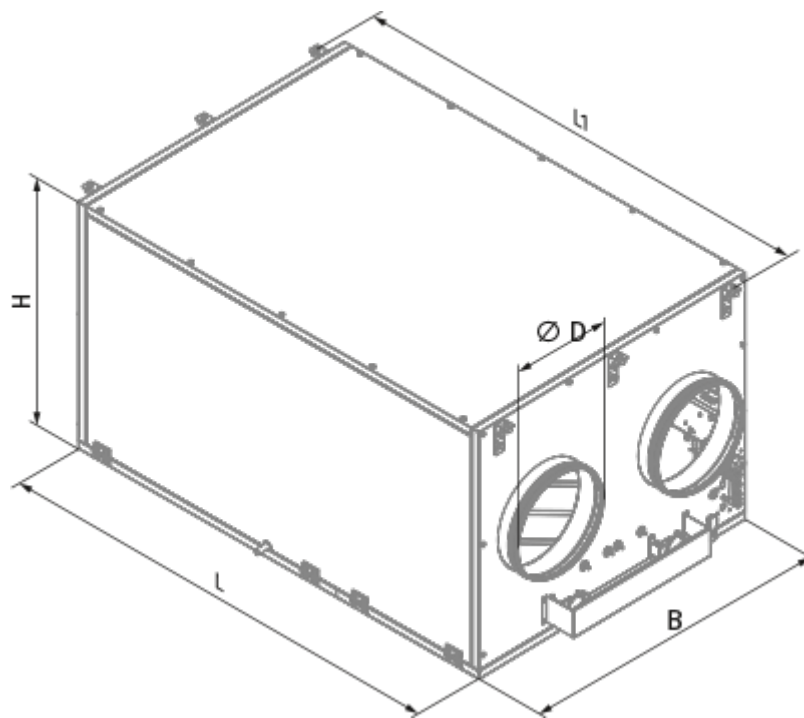



Accessories

Other accessories



Name	Photo	Description
FP 827x741x48 G4		G4 panel filter

Other accessories

Name	Photo	Description
S22		Control panels
S22 Wi-Fi		Control panels
S25		LCD control panel

Other accessories

Name	Photo	Description
------	-------	-------------

FS2		Humidity sensor
CD-1		CO2 sensors
CD-2		CO2 sensors







Other accessories





Name	Photo	Description
SFK 20x32		Hydraulic syphon for condensate drainage

Other accessories

Name	Photo	Description
VKA 400		Air dampers for round ducts

Other accessories

Name	Photo	Description
WMG 3/4-4		Water mixing units
WMG 3/4-6		Water mixing units
WMG 1-6		Water mixing units
WMG 1-10		Water mixing units
WMG 1 1/4-10		Water mixing units
WMG 1 1/4-16		Water mixing units

WMG 1 1/2-16		Water mixing units
WMG 1 1/2-25		Water mixing units
WMG 2-25		Water mixing units
WMG 2-40		Water mixing units

Other accessories

Name	Photo	Description
Belimo TF230		Electric actuators