

KOMFORT EC DBE 900 L S21 DTV

Suspended heat recovery air handling units



- Power of electrical reheater: 3300
- Maximum airflow: 1030
- Sound pressure level LpA at 3 m: 33
- Heat exchanger type: Counter flow
- Extract filter: G4
- Supply filter: G4 (опция: F7), G4 (F7 option)
- Sound insulation
- Motor type: EC
- Bypass: Auto
- Reheater: Electric
- Preheater: Optional
- BMS protocol: ModBus
- Control: Smartphone
- Casing material: Galvanized steel
- Humidity sensor: Optional
- CO2 sensor: Optional
- VOC sensor: Optional
- PM2.5 sensor: Optional

	Unit of measurement	KOMFORT EC DBE 900 L S21 DTV
Connected air duct size	mm	250
Speed	-	1
Phases	-	1
Minimum supply voltage	V	230
Maximum supply voltage	V	230
Power supply frequency	Hz	50/60
Rated power	W	442
Power of electrical reheater	W	3300
Unit current	A	17.4
Maximum airflow	m ³ /h	1030
Sound pressure level LpA at 3 m	dB(A)	33
Heat recovery efficiency, max	%	88
Heat exchanger type	-	Counter flow
Heat exchanger material	-	Polystyrene
Weight	kg	111
Extract filter	-	G4
Supply filter	-	G4 (опция: F7), G4 (F7 option)
Transported air temperature (max)	°C	40
Transported air temperature (min)	°C	-25

Ambient air temperature min	°C	1
Ambient air temperature max	°C	40
Ambient air humidity max	%	60
Ingress protection rating	-	IP22
Ingress protection rating of the drive	-	IP44

Dimensions

Ø D	B	B1	H	L	L1
250	1351	1485	318	1349	1402

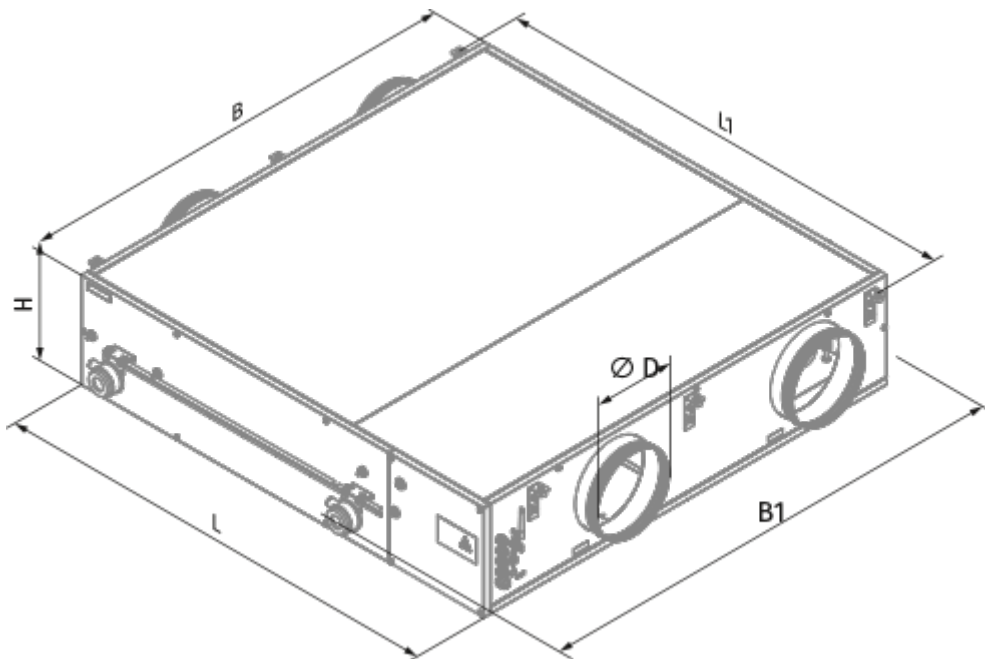

Ecodesign

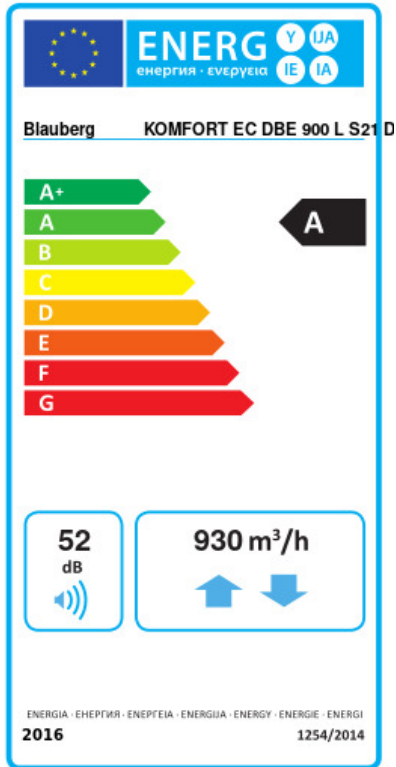

Trademark	Blauberg		
Model	KOMFORT EC DBE 900 L S21 DTV		
Specific energy consumption (SEC) (kWh/(m ² /a))	Cold	Average	Warm
	78.1	A+	16.7
Type of ventilation unit	Bidirectional		
Type of drive installed	Variable speed		
Type of heat recovery system	Recuperative		
Thermal efficiency of heat recovery (%)	79		
Maximum flow rate (m ³ /h)	930		
Electric power input (W)	442		
Reference flow rate (m ³ /s)	0.169		
Reference pressure difference (Pa)	50		
Specific power input (SPI) (W/(m ³ /h))	0.261		
Control typology	Local demand control		
Maximum internal leakage rates (%)	2.7		
Maximum external leakage rates (%)	2.7		
Sound power level (dB(A))	52		
Declared typology	RVU BVU		
The annual electricity consumption (AEC) (kWh/a)	Cold	Average	Warm
	720	183	138
The annual heating saved (AHS) (kWh/a)	Cold	Average	Warm
	8736	4466	2019



Accessories

Other accessories

Name	Photo	Description
FP 647x274x20 G4		G4 panel filter
FPT 647x274x27 G4		

FPT 647x274x27 F7



Control Panels

Name	Photo	Description
S22		Control panels
S22 Wi-Fi		Control panels
S25		LCD control panel

Humidity sensors

Name	Photo	Description
FS2		Humidity sensor

CO2 sensors



Name	Photo	Description
CD-1		CO2 sensors
CD-2		CO2 sensors

Other accessories

Name	Photo	Description
DAH 251-13		Kitchen exhaust hood

Electrical heaters



Name	Photo	Description
EVH 250-1.2-1 S21 V.2		Electric duct preheater for heat exchanger freeze protection

EVH 250-2.0-1 S21 V.2		Electric duct preheater for heat exchanger freeze protection
EVH 250-3.0-1 S21 V.2		Electric duct preheater for heat exchanger freeze protection

Condensation drainage

Name	Photo	Description
SFK 20x32		Hydraulic syphon for condensate drainage

For round ducts

Name	Photo	Description
SD 250/600		Silencers for round ducts
SD 250/900		Silencers for round ducts
SD 250/1200		Silencers for round ducts

For round ducts

Name	Photo	Description
VRV 250		Backdraft dampers with spring for round ducts
VKA 250		Air dampers for round ducts

Electric actuators

Name	Photo	Description
Belimo TF230		Electric actuators