

KOMFORT EC DBE 900-E R S21 DTV

Suspended heat recovery air handling units



- Power of electrical reheater: 3300
- Maximum airflow: 1030
- Sound pressure level LpA at 3 m: 33
- Heat exchanger type: Counter flow
- Extract filter: G4
- Supply filter: G4 (F7 option)
- Sound insulation
- Motor type: EC
- Enthalpy heat exchanger
- Bypass: Auto
- Reheater: Electric
- Preheater: Optional
- BMS protocol: ModBus
- Control: Smartphone
- Casing material: Galvanized steel
- Humidity sensor: Optional
- CO2 sensor: Optional
- VOC sensor: Optional
- PM2.5 sensor: Optional

	Unit of measurement	KOMFORT EC DBE 900-E R S21 DTV
Connected air duct size	mm	250
Speed	-	1
Phases	-	1
Minimum supply voltage	V	230
Maximum supply voltage	V	230
Power supply frequency	Hz	50/60
Rated power	W	442
Power of electrical reheater	W	3300
Unit current	A	17.4
Maximum airflow	m ³ /h	1030
Sound pressure level LpA at 3 m	dB(A)	33
Heat recovery efficiency, max	%	85
Heat exchanger type	-	Counter flow
Heat exchanger material	-	Enthalpy
Weight	kg	111
Extract filter	-	G4
Supply filter	-	G4 (F7 option)
Transported air temperature (max)	°C	40

Transported air temperature (min)	°C	-25
Ambient air temperature min	°C	1
Ambient air temperature max	°C	40
Ambient air humidity max	%	60
Ingress protection rating	-	IP22
Ingress protection rating of the drive	-	IP44

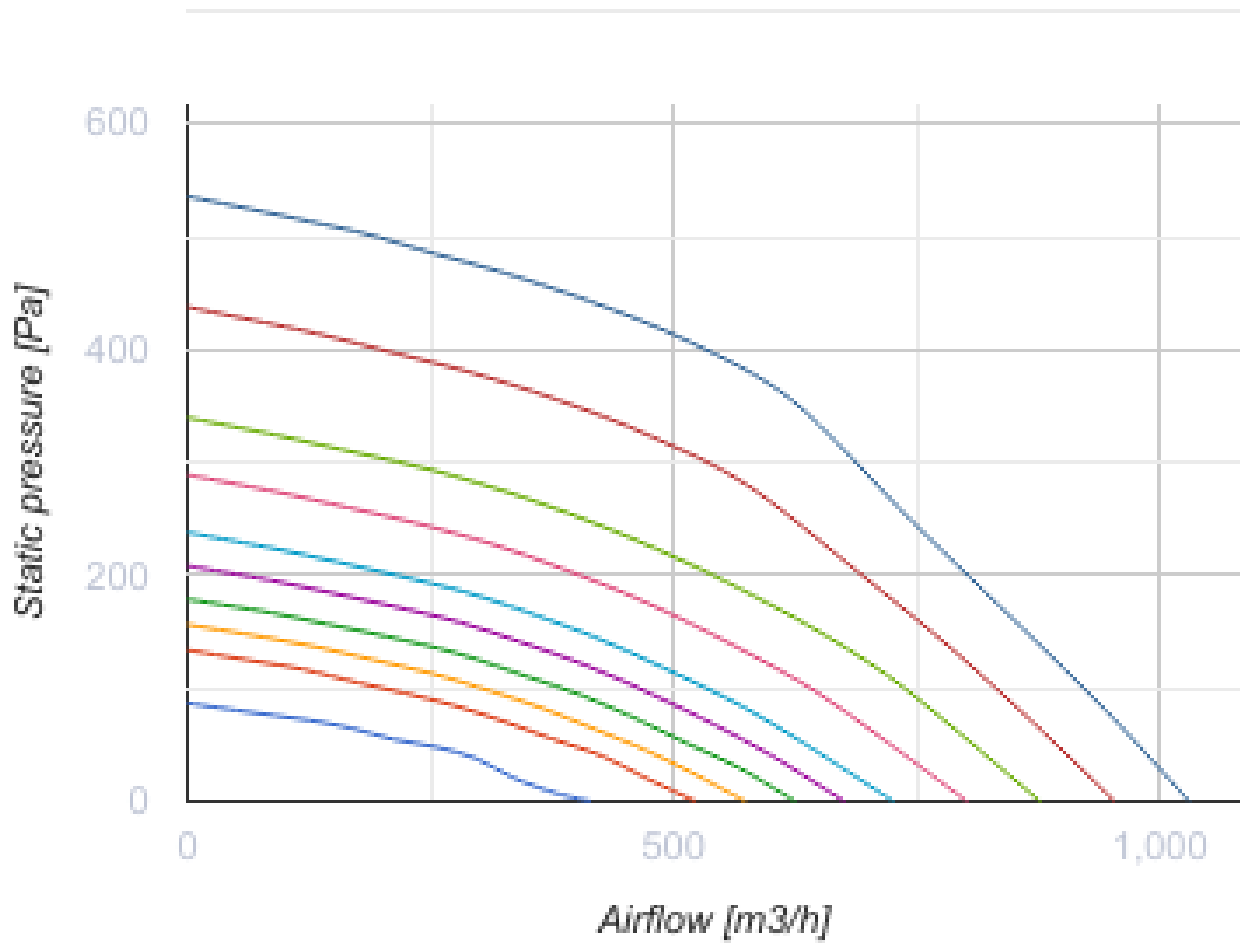

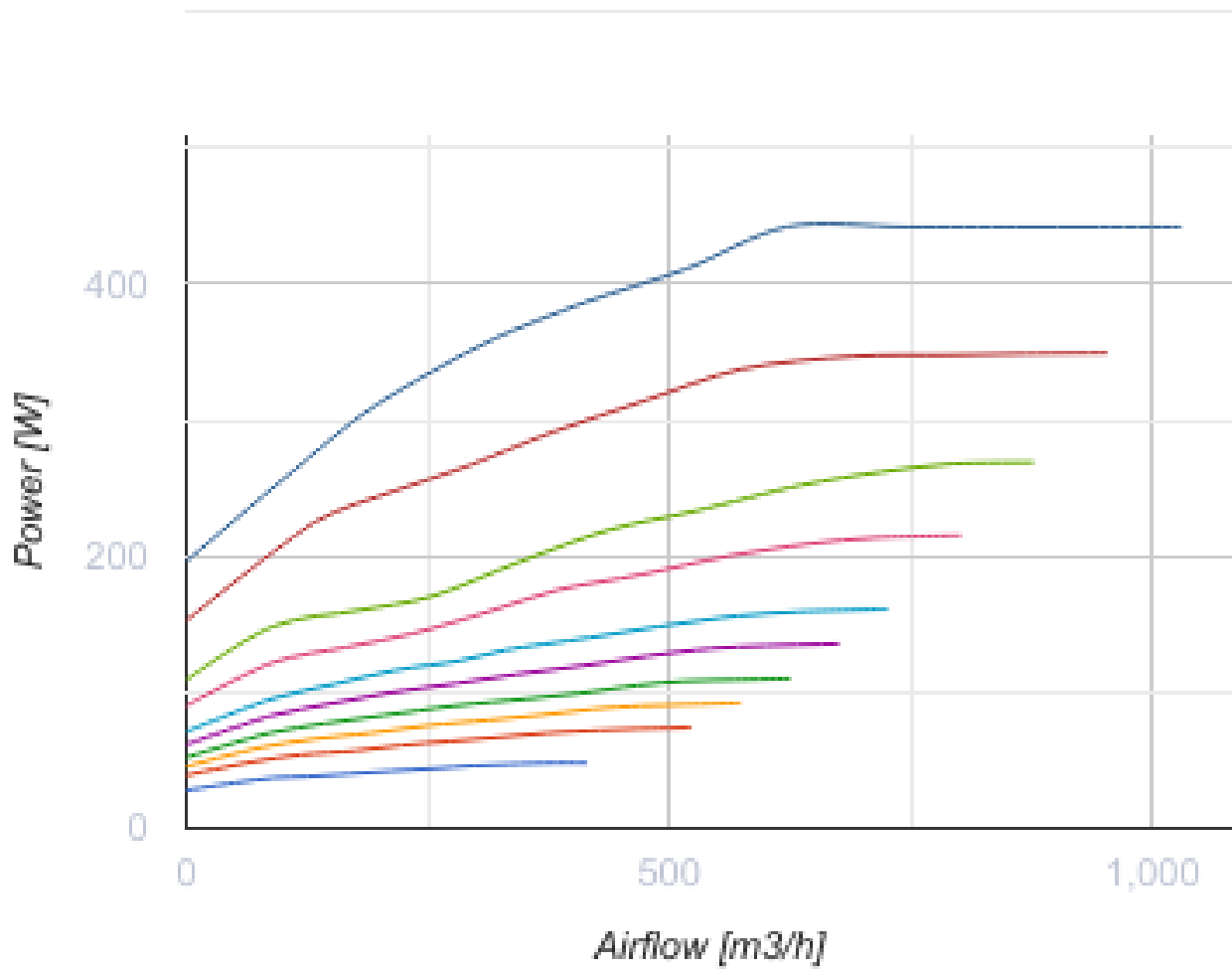

Dimensions

Ø D	B	B1	H	L	L1
250	1351	1485	318	1349	1402

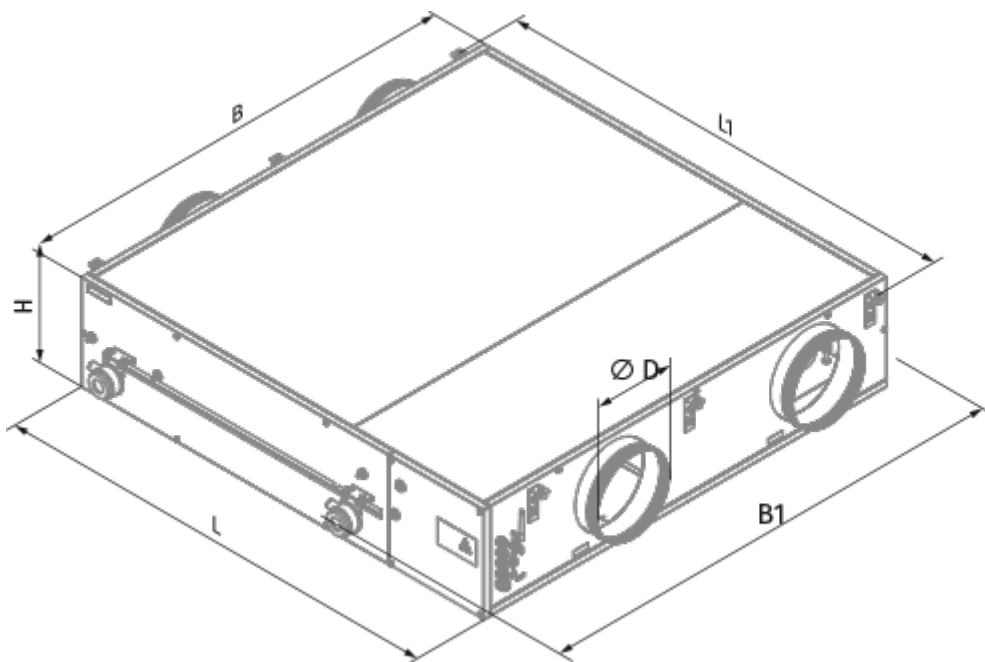



Accessories

Other accessories

Name	Photo	Description
FP 647x274x20 G4		G4 panel filter
FPT 647x274x27 G4		
FPT 647x274x27 F7		

Control Panels



Name	Photo	Description
S22		Control panels
S22 Wi-Fi		Control panels
S25		LCD control panel

Humidity sensors



Name	Photo	Description
------	-------	-------------

FS2		Humidity sensor
---------------------	---	-----------------



CO2 sensors

Name	Photo	Description
CD-1		CO2 sensors
CD-2		CO2 sensors

Electrical heaters

Name	Photo	Description
EVH 250-1.2-1 S21 V.2		Electric duct preheater for heat exchanger freeze protection
EVH 250-2.0-1 S21 V.2		Electric duct preheater for heat exchanger freeze protection
EVH 250-3.0-1 S21 V.2		Electric duct preheater for heat exchanger freeze protection

For round ducts

Name	Photo	Description
SD 250/600		Silencers for round ducts
SD 250/900		Silencers for round ducts
SD 250/1200		Silencers for round ducts

For round ducts

Name	Photo	Description
VRV 250		Backdraft dampers with spring for round ducts

VKA 250		Air dampers for round ducts
-------------------------	---	-----------------------------

Electric actuators

Name	Photo	Description
Belimo TF230		Electric actuators