

KOMFORT EC DBE 550-E L S21 DTV

Suspended heat recovery air handling units



- Power of electrical reheater: 2000
- Maximum airflow: 608
- Sound pressure level LpA at 3 m: 30
- Heat exchanger type: Counter flow
- Extract filter: G4
- Supply filter: G4 (опция: F7), G4 (F7 option)
- Sound insulation
- Motor type: EC
- Enthalpy heat exchanger
- Bypass: Auto
- Reheater: Electric
- Preheater: Optional
- BMS protocol: ModBus
- Control: Smartphone
- Casing material: Galvanized steel
- Humidity sensor: Optional
- CO2 sensor: Optional
- VOC sensor: Optional
- PM2.5 sensor: Optional

	Unit of measurement	KOMFORT EC DBE 550-E L S21 DTV
Connected air duct size	mm	200
Speed	-	1
Phases	-	1
Minimum supply voltage	V	230
Maximum supply voltage	V	230
Power supply frequency	Hz	50/60
Rated power	W	322
Power of electrical reheater	W	2000
Unit current	A	11.1
Maximum airflow	m ³ /h	608
Sound pressure level LpA at 3 m	dB(A)	30
Heat recovery efficiency, max	%	87
Heat exchanger type	-	Counter flow
Heat exchanger material	-	Enthalpy
Weight	kg	67
Extract filter	-	G4
Supply filter	-	G4 (опция: F7), G4 (F7 option)
Transported air temperature (max)	°C	40

Transported air temperature (min)	°C	-25
Ambient air temperature min	°C	1
Ambient air temperature max	°C	40
Ambient air humidity max	%	60
Ingress protection rating	-	IP22
Ingress protection rating of the drive	-	IP44

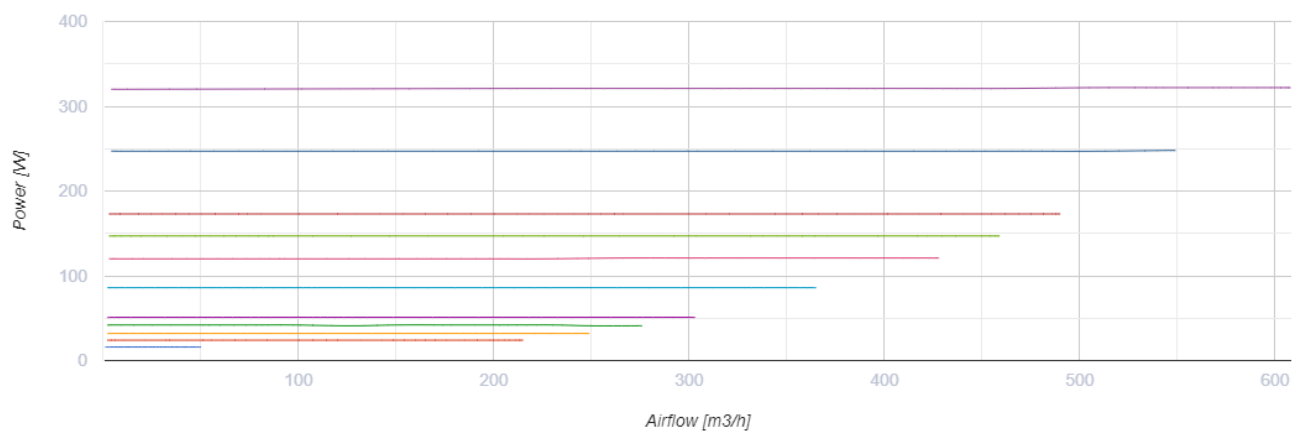
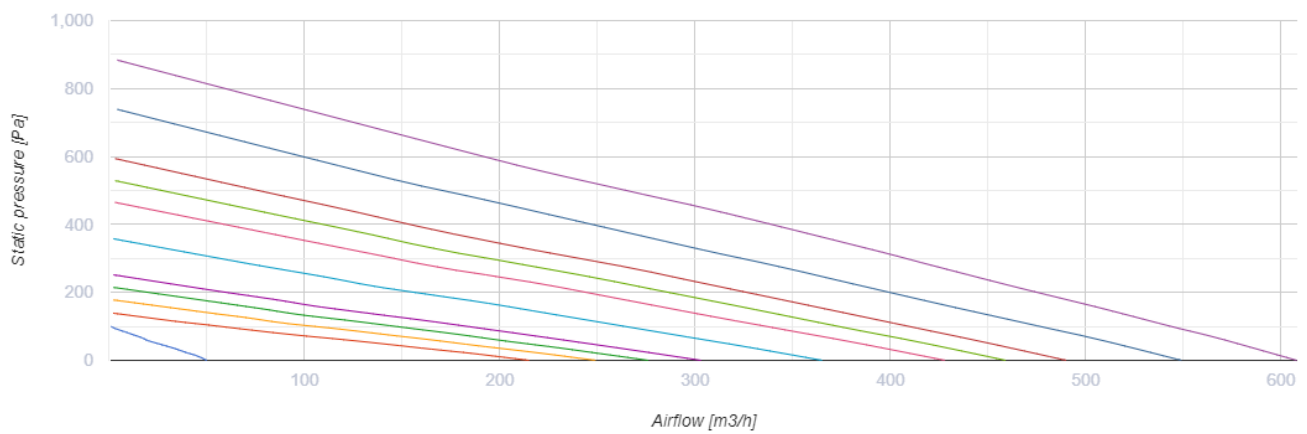

Dimensions

Ø D	B	B1	H	L	L1
200	827	960	280	1238	1291

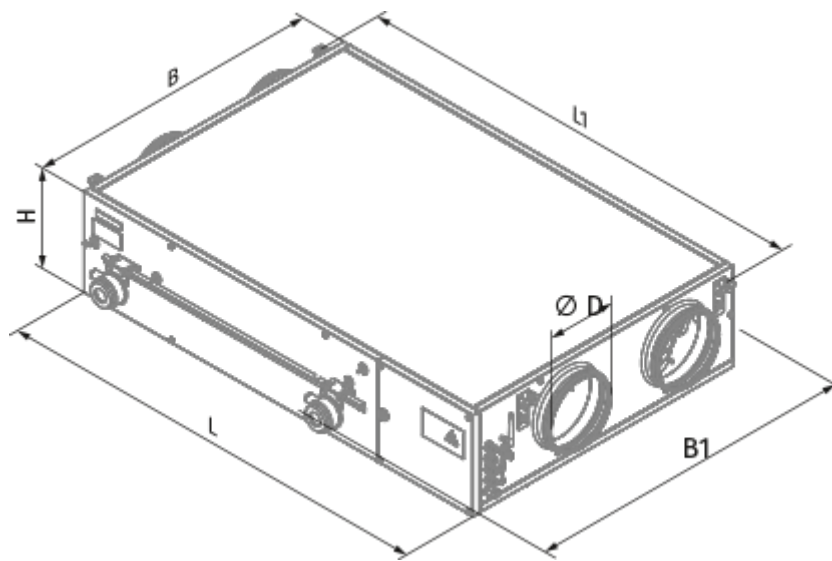



Accessories

Other accessories

Name	Photo	Description
FP 782x128x20 G4		G4 panel filter
FPT 392x236x27 G4		
FPT 392x236x27 F7		

Control Panels



Name	Photo	Description
S22		Control panels
S22 Wi-Fi		Control panels
S25		LCD control panel

Humidity sensors

Name	Photo	Description
------	-------	-------------

FS2		Humidity sensor
---------------------	---	-----------------



CO2 sensors

Name	Photo	Description
CD-1		CO2 sensors
CD-2		CO2 sensors

Other accessories

Name	Photo	Description
DAH 251-13		Kitchen exhaust hood

Electrical heaters

Name	Photo	Description
EVH 200-1.2-1 S21 V.2		Electric duct preheater for heat exchanger freeze protection
EVH 200-1.7-1 S21 V.2		Electric duct preheater for heat exchanger freeze protection
EVH 200-2.0-1 S21 V.2		Electric duct preheater for heat exchanger freeze protection

Condensation drainage

Name	Photo	Description
SFK 20x32		Hydraulic syphon for condensate drainage

For round ducts

Name	Photo	Description
SD 200/600		Silencers for round ducts

SD 200/900		Silencers for round ducts
SD 200/1200		Silencers for round ducts

For round ducts

Name	Photo	Description
VRV 200		Backdraft dampers with spring for round ducts
VKA 200		Air dampers for round ducts

Electric actuators

Name	Photo	Description
Belimo TF230		Electric actuators