

KOMFORT EC DBE 3000 S21

Suspended heat recovery air handling units



- Power of electrical reheater: 21000
- Maximum airflow: 4300
- Sound pressure level LpA at 3 m: 46
- Heat exchanger type: Cross flow
- Extract filter: G4
- Supply filter: G4
- Sound insulation
- Motor type: EC
- Bypass: Auto
- Reheater: Electric
- BMS protocol: ModBus
- Control: Smartphone
- Casing material: Galvanized steel
- Humidity sensor: Optional
- CO2 sensor: Optional
- VOC sensor: Optional
- PM2.5 sensor: Optional

	Unit of measurement	KOMFORT EC DBE 3000 S21
Connected air duct size	mm	400
Speed	-	1
Phases	-	3
Minimum supply voltage	V	400
Maximum supply voltage	V	400
Power supply frequency	Hz	50/60
Rated power	W	2226
Power of electrical reheater	W	21000
Unit current	A	33.5
Maximum airflow	m ³ /h	4300
Sound pressure level LpA at 3 m	dB(A)	46
Heat recovery efficiency, max	%	72
Heat exchanger type	-	Cross flow
Heat exchanger material	-	Aluminum
Weight	kg	281
Extract filter	-	G4
Supply filter	-	G4
Transported air temperature (max)	°C	40
Transported air temperature (min)	°C	-25

Ambient air temperature min	°C	1
Ambient air temperature max	°C	40
Ambient air humidity max	%	60
Ingress protection rating	-	IP22
Ingress protection rating of the drive	-	IP44

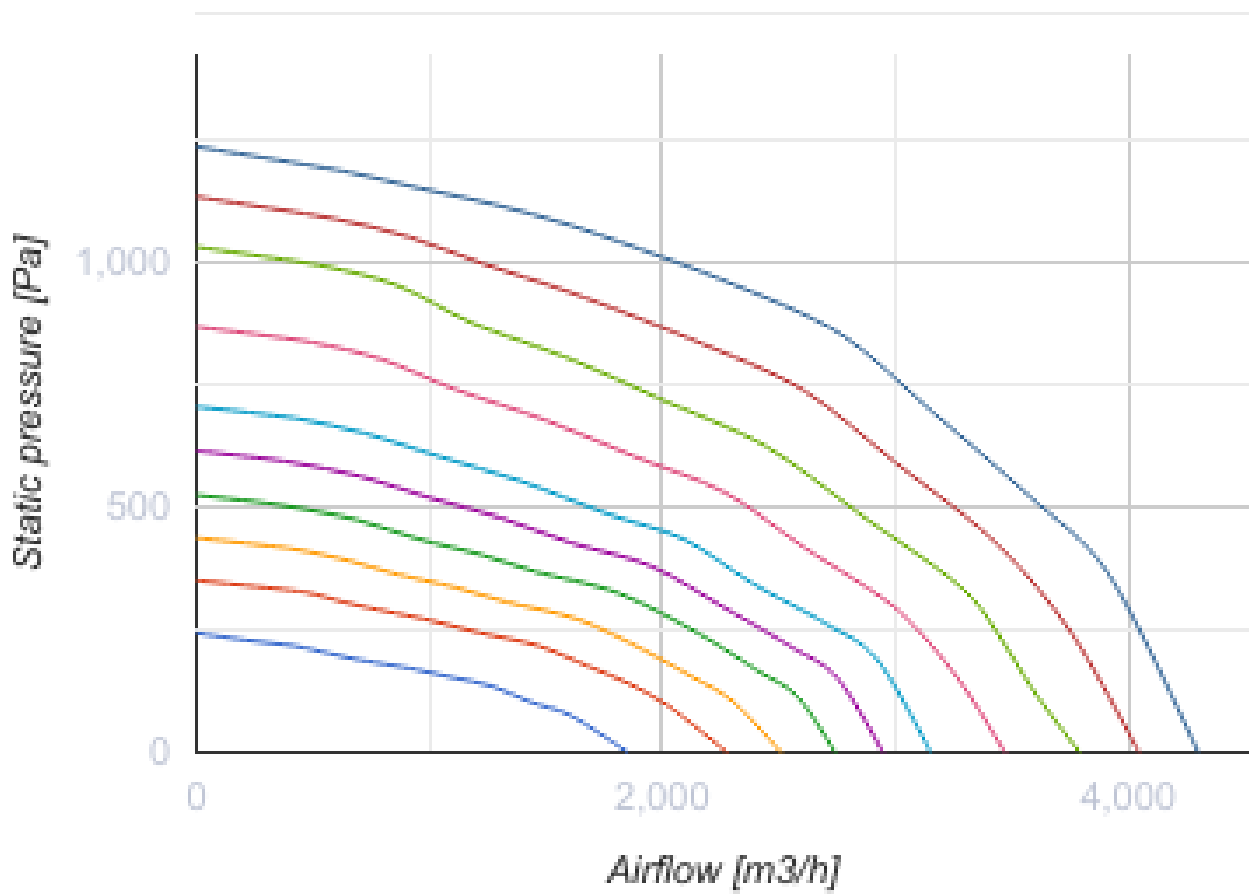

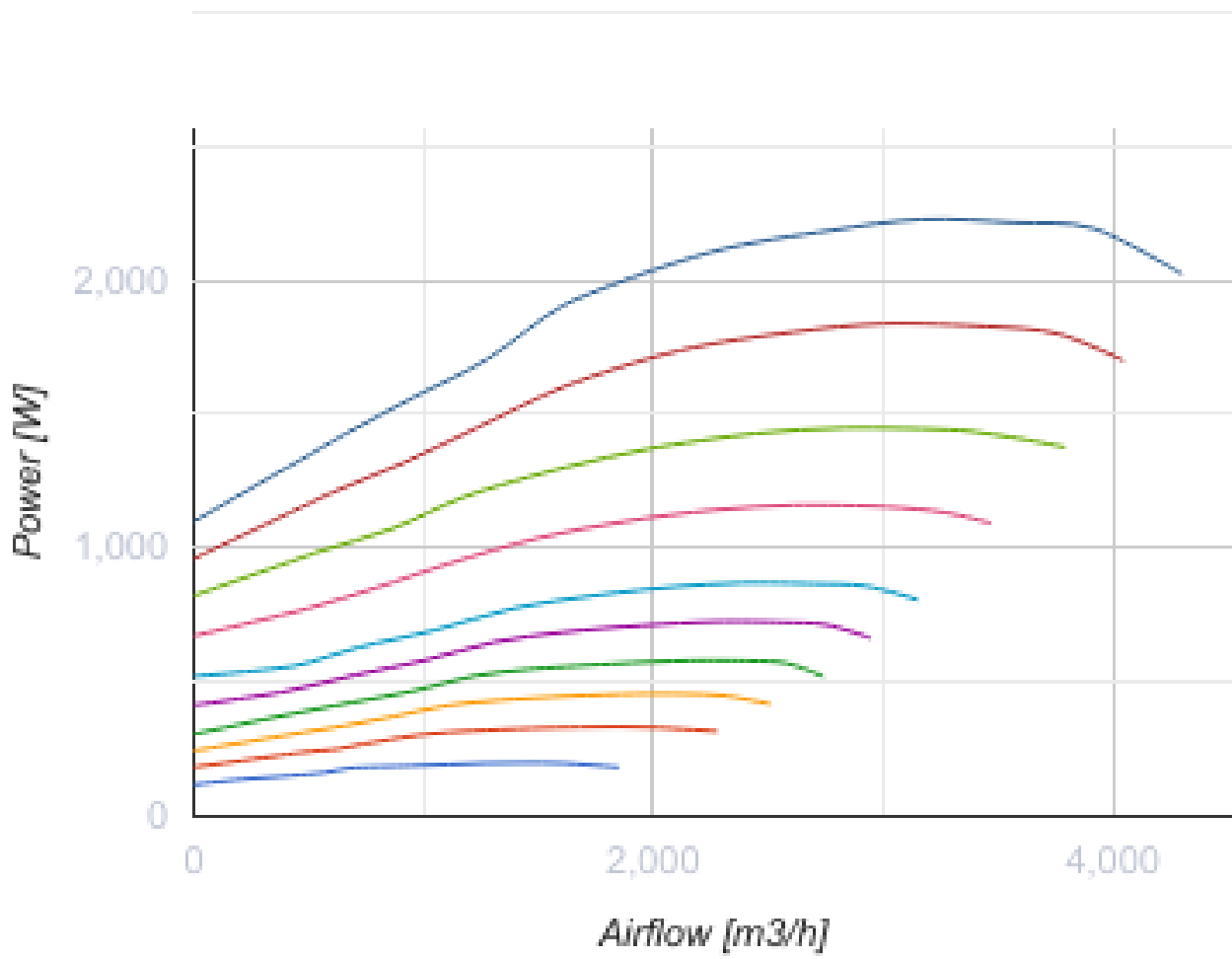

Dimensions

Ø D	B	H	L	L1
400	1265	854	1835	1888

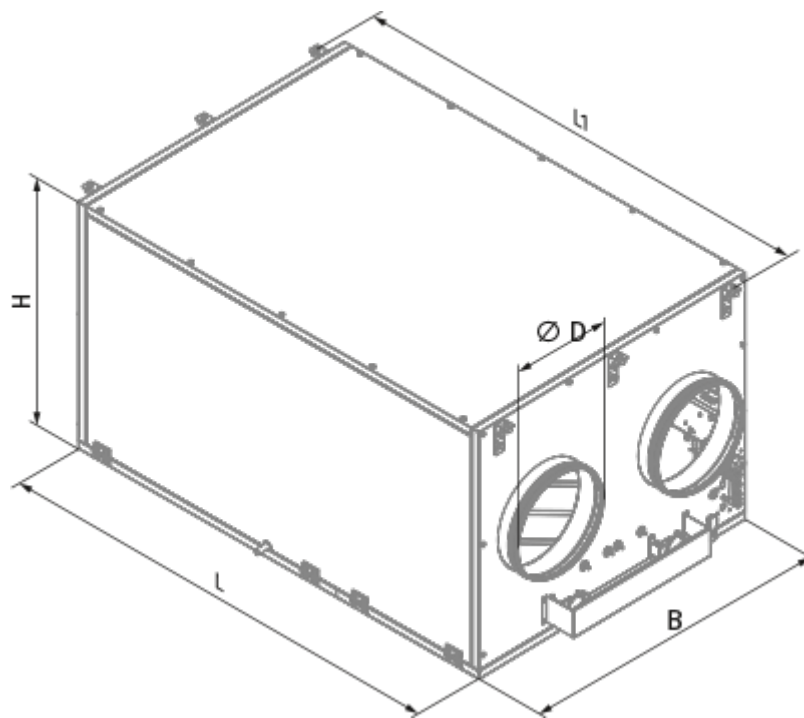



Accessories

Other accessories

Name	Photo	Description
FP 827x741x48 G4		G4 panel filter

Control Panels



Name	Photo	Description
S22		Control panels
S22 Wi-Fi		Control panels
S25		LCD control panel

Humidity sensors

Name	Photo	Description
------	-------	-------------

FS2		Humidity sensor
---------------------	---	-----------------

CO2 sensors

Name	Photo	Description
CD-1		CO2 sensors
CD-2		CO2 sensors



Other accessories

Name	Photo	Description
DAH 251-13		Kitchen exhaust hood

Condensation drainage

Name	Photo	Description
SFK 20x32		Hydraulic syphon for condensate drainage

For round ducts

Name	Photo	Description
SD 400/900		Silencers for round ducts
SD 400/1200		Silencers for round ducts

For round ducts

Name	Photo	Description
VKA 400		Air dampers for round ducts

Electric actuators

Name	Photo	Description
Belimo TF230		Electric actuators