

KOMFORT EC DBE 300-E R S21 DTV

Suspended heat recovery air handling units



- Power of electrical reheater: 1500
- Maximum airflow: 340
- Sound pressure level LpA at 3 m: 27
- Heat exchanger type: Counter flow
- Extract filter: G4
- Supply filter: G4 (F7 option)
- Sound insulation
- Motor type: EC
- Enthalpy heat exchanger
- Bypass: Auto
- Reheater: Electric
- Preheater: Optional
- BMS protocol: ModBus
- Control: Smartphone
- Casing material: Galvanized steel
- Humidity sensor: Optional
- CO2 sensor: Optional
- VOC sensor: Optional
- PM2.5 sensor: Optional

	Unit of measurement	KOMFORT EC DBE 300-E R S21 DTV
Connected air duct size	mm	160
Speed	-	1
Phases	-	1
Minimum supply voltage	V	230
Maximum supply voltage	V	230
Power supply frequency	Hz	50/60
Rated power	W	180
Power of electrical reheater	W	1500
Unit current	A	7.9
Maximum airflow	m ³ /h	340
Sound pressure level LpA at 3 m	dB(A)	27
Heat recovery efficiency, max	%	87
Heat exchanger type	-	Counter flow
Heat exchanger material	-	Polystyrene
Weight	kg	44
Extract filter	-	G4
Supply filter	-	G4 (F7 option)
Transported air temperature (max)	°C	40

Transported air temperature (min)	°C	-25
Ambient air temperature min	°C	1
Ambient air temperature max	°C	40
Ambient air humidity max	%	60
Ingress protection rating	-	IP22
Ingress protection rating of the drive	-	IP44

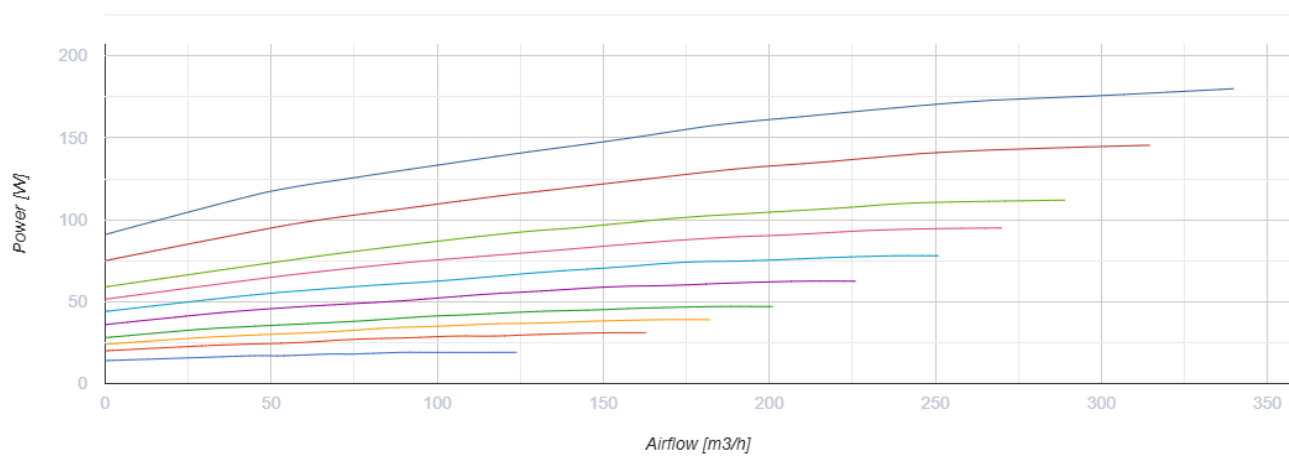
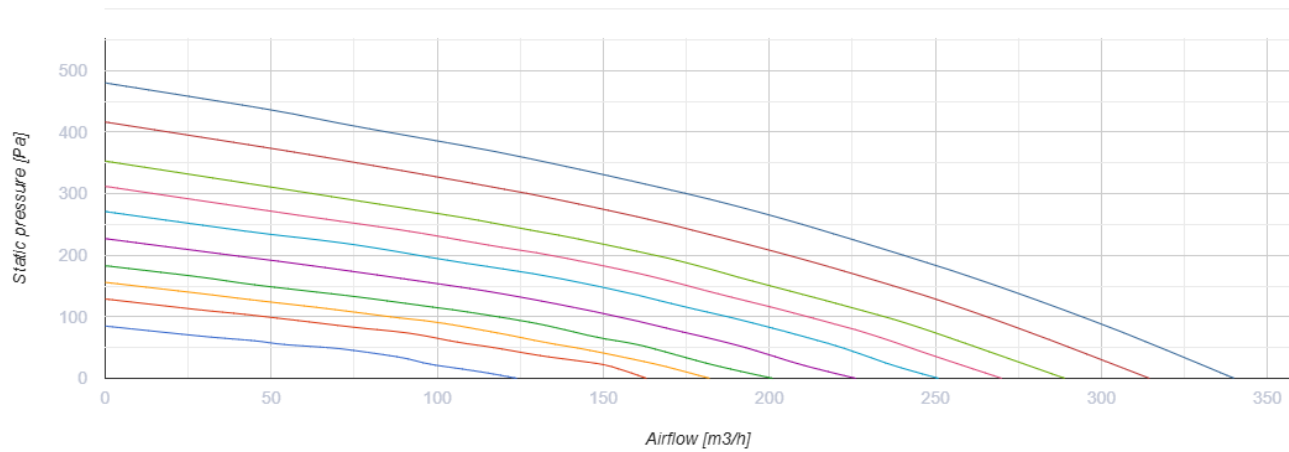

Dimensions

Ø D	B	B1	H	L	L1
160	485	577	290	1238	1291

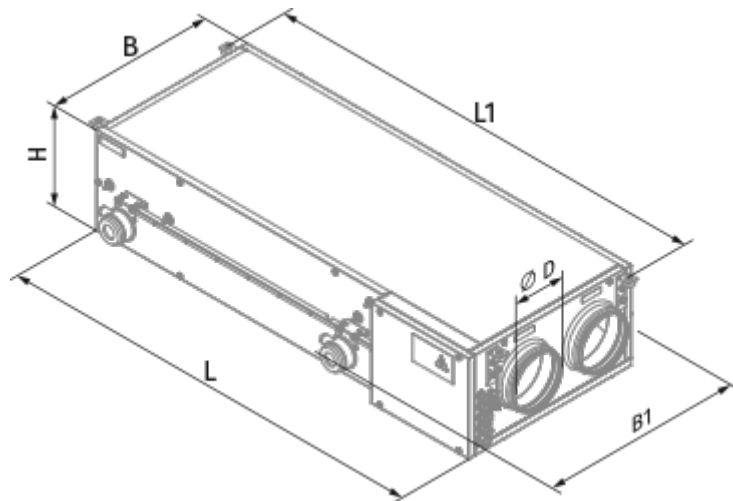

Accessories

Other accessories

Name	Photo	Description
FP 440x128x20 G4		G4 panel filter
FPT 208x236x27 G4		
FPT 208x236x27 F7		

Other accessories





Name	Photo	Description
S22		Control panels
S22 Wi-Fi		Control panels
S25		LCD control panel

Other accessories



Name	Photo	Description
FS2		Humidity sensor

CD-1		CO2 sensors
CD-2		CO2 sensors



Other accessories

Name	Photo	Description
EVH 160-0.8-1 S21 V.2		Electric duct preheater for heat exchanger freeze protection
EVH 160-1.2-1 S21 V.2		Electric duct preheater for heat exchanger freeze protection
EVH 160-1.7-1 S21 V.2		Electric duct preheater for heat exchanger freeze protection
EVH 160-2.0-1 S21 V.2		Electric duct preheater for heat exchanger freeze protection

Other accessories

Name	Photo	Description
SD 160/600		Silencers for round ducts
SD 160/900		Silencers for round ducts
SD 160/1200		Silencers for round ducts

Other accessories

Name	Photo	Description
VRV 160		Backdraft dampers with spring for round ducts
VKA 160		Air dampers for round ducts

Other accessories

Name	Photo	Description
Belimo TF230		Electric actuators