

KOMFORT EC DBE 2000 S21 DTV

Suspended heat recovery air handling units

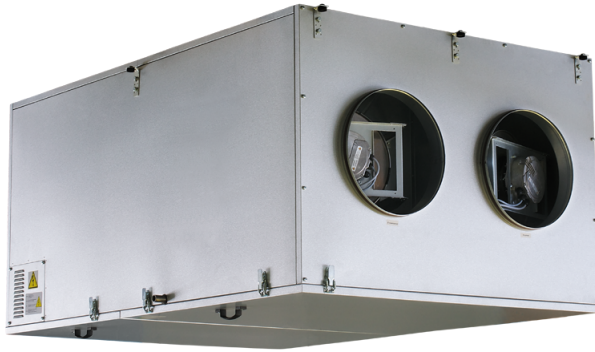

- Power of electrical reheater: 15000
- Maximum airflow: 2100
- Sound pressure level LpA at 3 m: 36
- Heat exchanger type: Cross flow
- Extract filter: G4
- Supply filter: G4
- Sound insulation
- Motor type: EC
- Bypass: Auto
- Reheater: Electric
- BMS protocol: ModBus
- Control: Smartphone
- Casing material: Galvanized steel
- Humidity sensor: Optional
- CO2 sensor: Optional
- VOC sensor: Optional
- PM2.5 sensor: Optional

	Unit of measurement	KOMFORT EC DBE 2000 S21 DTV
Connected air duct size	mm	315
Speed	-	1
Phases	-	3
Minimum supply voltage	V	400
Maximum supply voltage	V	400
Power supply frequency	Hz	50/60
Rated power	W	1063
Power of electrical reheater	W	15000
Unit current	A	26.4
Maximum airflow	m ³ /h	2100
Sound pressure level LpA at 3 m	dB(A)	36
Heat recovery efficiency, max	%	67
Heat exchanger type	-	Cross flow
Heat exchanger material	-	Aluminum
Weight	kg	140
Extract filter	-	G4
Supply filter	-	G4
Transported air temperature (max)	°C	40
Transported air temperature (min)	°C	-25

Ambient air temperature min	°C	1
Ambient air temperature max	°C	40
Ambient air humidity max	%	60
Ingress protection rating	-	IP22
Ingress protection rating of the drive	-	IP44

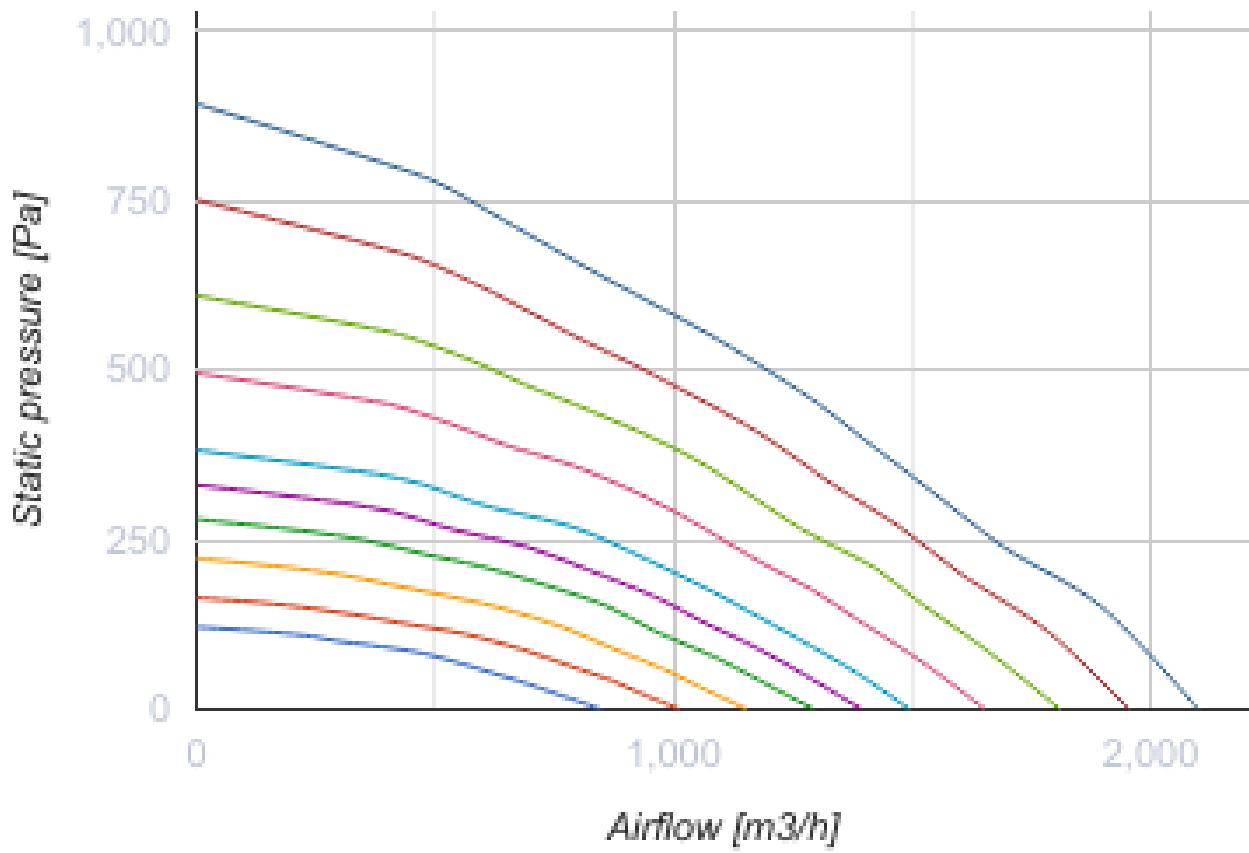

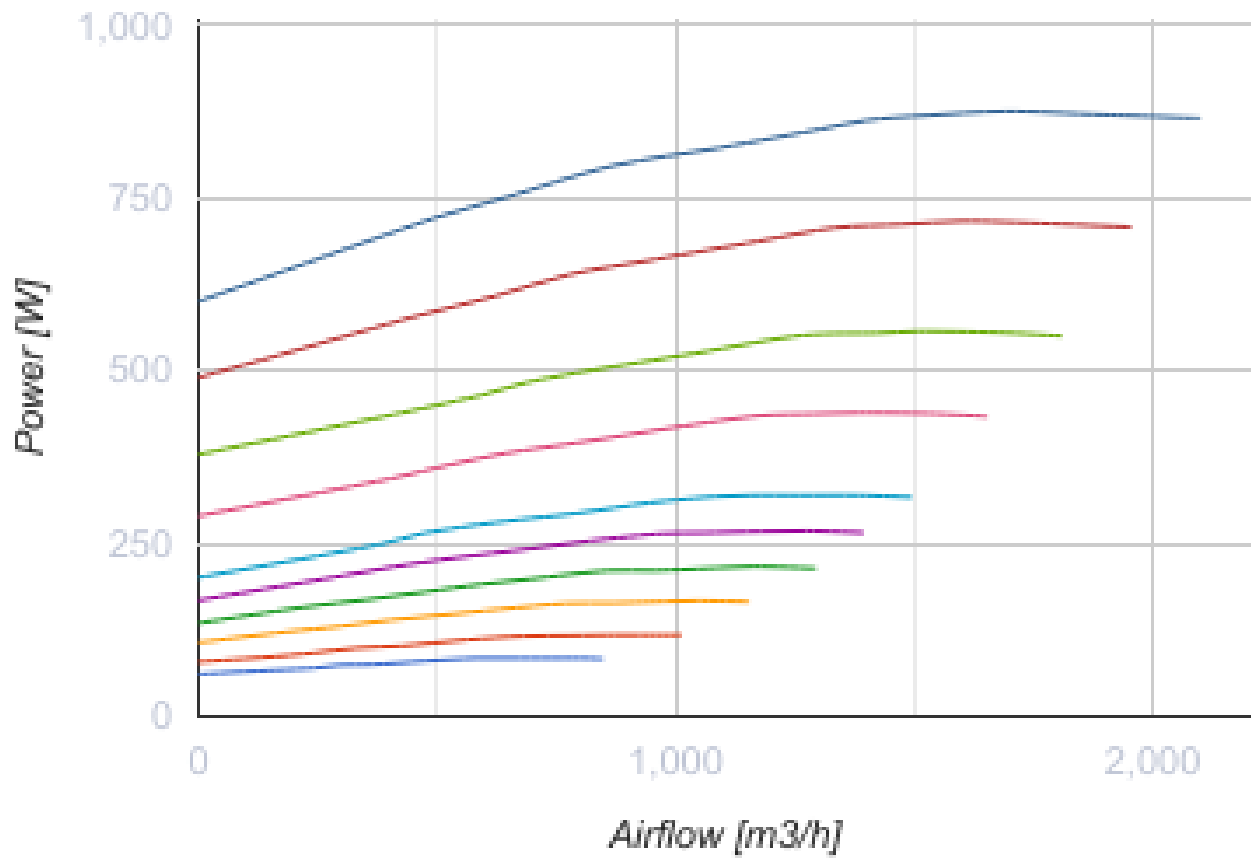

Dimensions

Ø D	B	H	L	L1
315	950	762	1400	1452

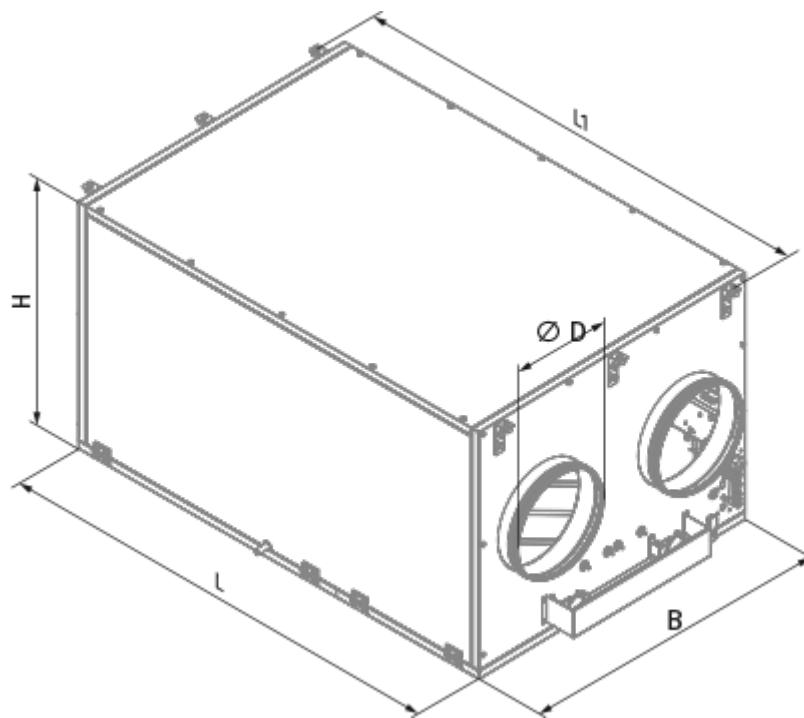



Accessories

Other accessories

Name	Photo	Description
FP 708x480x48 G4		G4 panel filter

Control Panels



Name	Photo	Description
S22		Control panels
S22 Wi-Fi		Control panels
S25		LCD control panel

Humidity sensors

Name	Photo	Description
------	-------	-------------

FS2		Humidity sensor
---------------------	---	-----------------



CO2 sensors

Name	Photo	Description
CD-1		CO2 sensors
CD-2		CO2 sensors

Condensation drainage

Name	Photo	Description
SFK 20x32		Hydraulic syphon for condensate drainage

For round ducts

Name	Photo	Description
SD 315/600		Silencers for round ducts
SD 315/900		Silencers for round ducts
SD 315/1200		Silencers for round ducts

For round ducts

Name	Photo	Description
VRV 315		Backdraft dampers with spring for round ducts
VKA 315		Air dampers for round ducts

Electric actuators

Name	Photo	Description
------	-------	-------------

[Belimo TF230](#)



Electric actuators