

# KOMFORT EC DBE 2000 S21

Suspended heat recovery air handling units

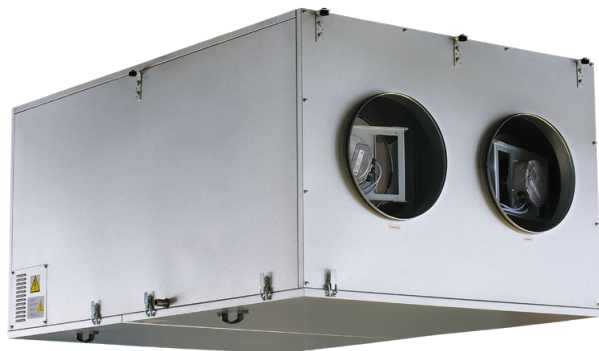

- Power of electrical reheater: 15000
- Maximum airflow: 2100
- Sound pressure level LpA at 3 m: 36
- Heat exchanger type: Cross flow
- Extract filter: G4
- Supply filter: G4
- Sound insulation
- Motor type: EC
- Bypass: Auto
- Reheater: Electric
- BMS protocol: ModBus
- Control: Smartphone
- Casing material: Galvanized steel
- Humidity sensor: Optional
- CO2 sensor: Optional
- VOC sensor: Optional
- PM2.5 sensor: Optional

	Unit of measurement	KOMFORT EC DBE 2000 S21
Connected air duct size	mm	315
Speed	-	1
Phases	-	3
Minimum supply voltage	V	400
Maximum supply voltage	V	400
Power supply frequency	Hz	50/60
Rated power	W	1063
Power of electrical reheater	W	15000
Unit current	A	26.4
Maximum airflow	m <sup>3</sup> /h	2100
Sound pressure level LpA at 3 m	dB(A)	36
Heat recovery efficiency, max	%	67
Heat exchanger type	-	Cross flow
Heat exchanger material	-	Aluminum
Weight	kg	140
Extract filter	-	G4
Supply filter	-	G4
Transported air temperature (max)	°C	40
Transported air temperature (min)	°C	-25

Ambient air temperature min	°C	1
Ambient air temperature max	°C	40
Ambient air humidity max	%	60
Ingress protection rating	-	IP22
Ingress protection rating of the drive	-	IP44

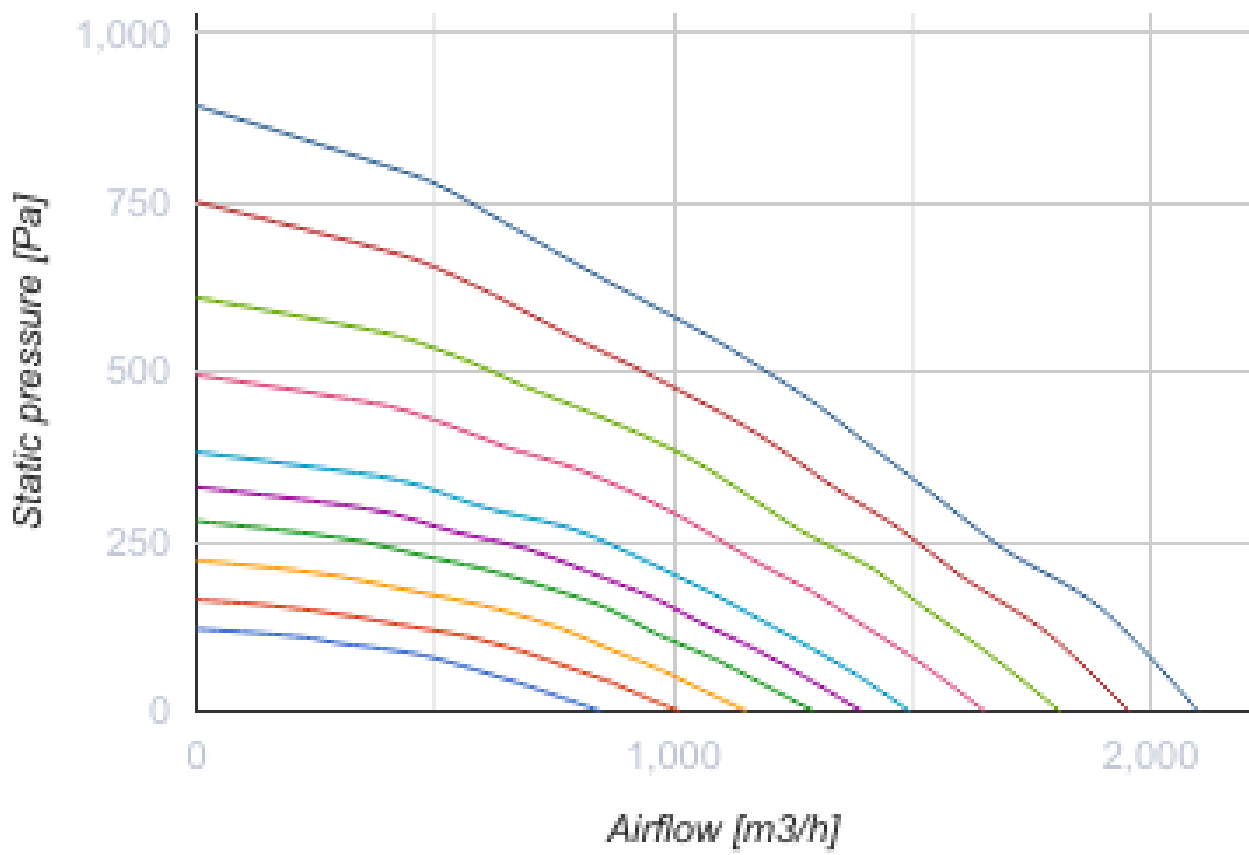

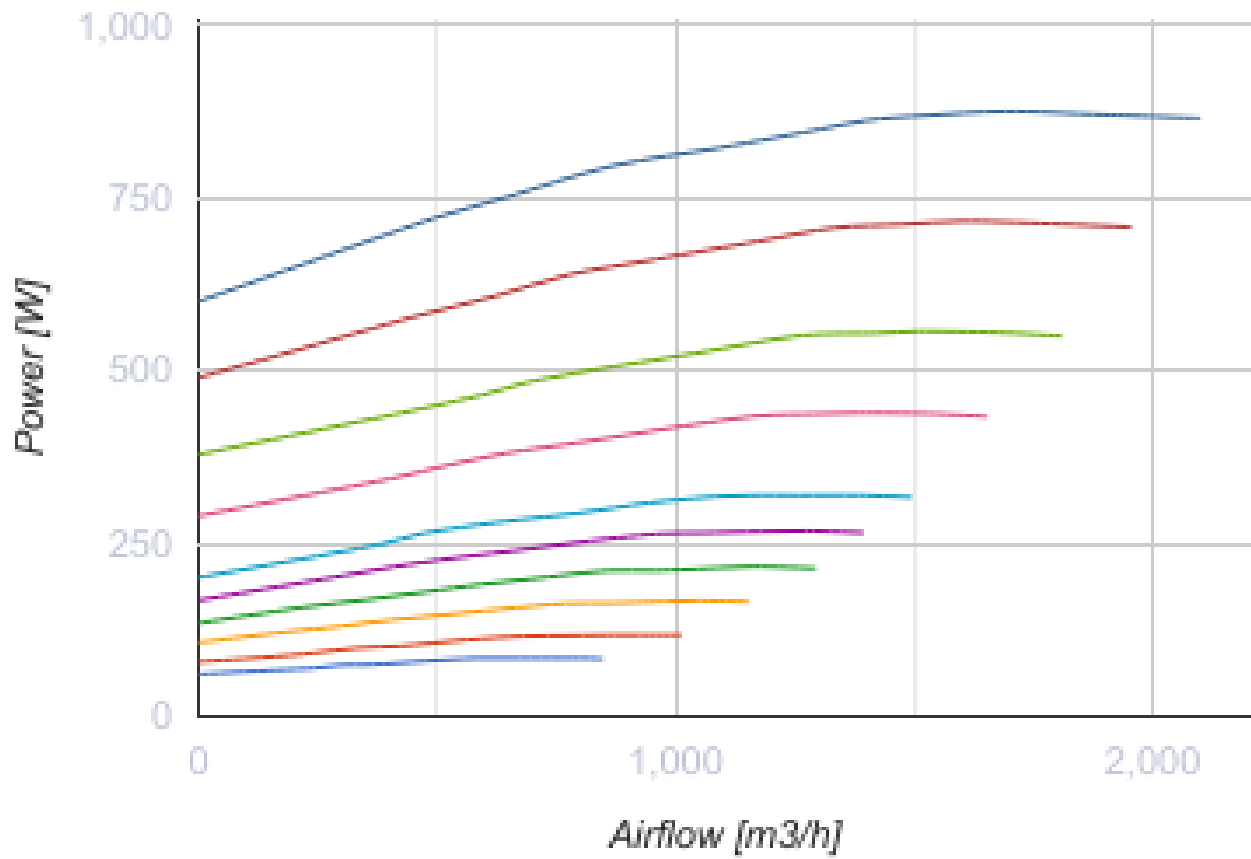

## Dimensions

Ø D	B	H	L	L1
315	950	762	1400	1452

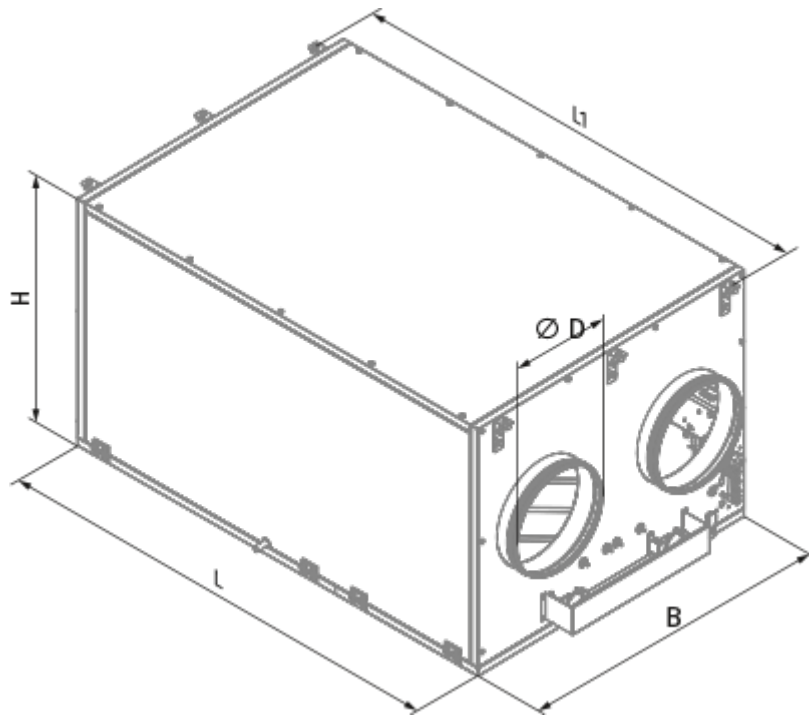



## Accessories

### Other accessories



Name	Photo	Description
FP 708x480x48 G4		G4 panel filter

### Other accessories

Name	Photo	Description
<a href="#">S22</a>		Control panels
<a href="#">S22 Wi-Fi</a>		Control panels
<a href="#">S25</a>		LCD control panel

### Other accessories



Name	Photo	Description
------	-------	-------------

<a href="#">FS2</a>		Humidity sensor
<a href="#">CD-1</a>		CO2 sensors
<a href="#">CD-2</a>		CO2 sensors

#### Other accessories

Name	Photo	Description
<a href="#">SFK 20x32</a>		Hydraulic syphon for condensate drainage

#### Other accessories

Name	Photo	Description
<a href="#">SD 315/600</a>		Silencers for round ducts
<a href="#">SD 315/900</a>		Silencers for round ducts
<a href="#">SD 315/1200</a>		Silencers for round ducts

#### Other accessories

Name	Photo	Description
<a href="#">VRV 315</a>		Backdraft dampers with spring for round ducts
<a href="#">VKA 315</a>		Air dampers for round ducts

#### Other accessories

Name	Photo	Description
------	-------	-------------

[Belimo TF230](#)



Electric actuators