

KOMFORT EC DB 250 R S21

Suspended heat recovery air handling units

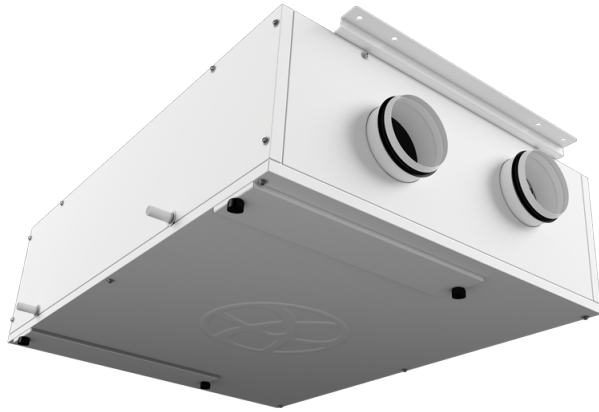

- Maximum airflow: 270
- Sound pressure level LpA at 3 m: 28
- Heat exchanger type: Counter flow
- Extract filter: G4
- Supply filter: F7
- Sound insulation
- Motor type: EC
- Bypass: Auto
- Reheater: Optional
- Preheater: Optional
- BMS protocol: ModBus
- Control: Smartphone
- Casing material: Galvanized steel
- Humidity sensor: Optional
- CO2 sensor: Optional
- VOC sensor: Optional
- PM2.5 sensor: Optional

	Unit of measurement	KOMFORT EC DB 250 R S21
Connected air duct size	mm	125
Speed	-	1
Phases	-	1
Minimum supply voltage	V	230
Maximum supply voltage	V	230
Power supply frequency	Hz	50/60
Rated power	W	101
Unit current	A	0.8
Maximum airflow	m ³ /h	270
Sound pressure level LpA at 3 m	dB(A)	28
Heat recovery efficiency, max	%	98
Heat exchanger type	-	Counter flow
Heat exchanger material	-	Polystyrene
Weight	kg	48
Extract filter	-	G4
Supply filter	-	F7
Transported air temperature (max)	°C	40
Transported air temperature (min)	°C	-25
Ambient air temperature min	°C	1

Ambient air temperature max	°C	40
Ambient air humidity max	%	80
Ingress protection rating	-	IP22
Ingress protection rating of the drive	-	IP44

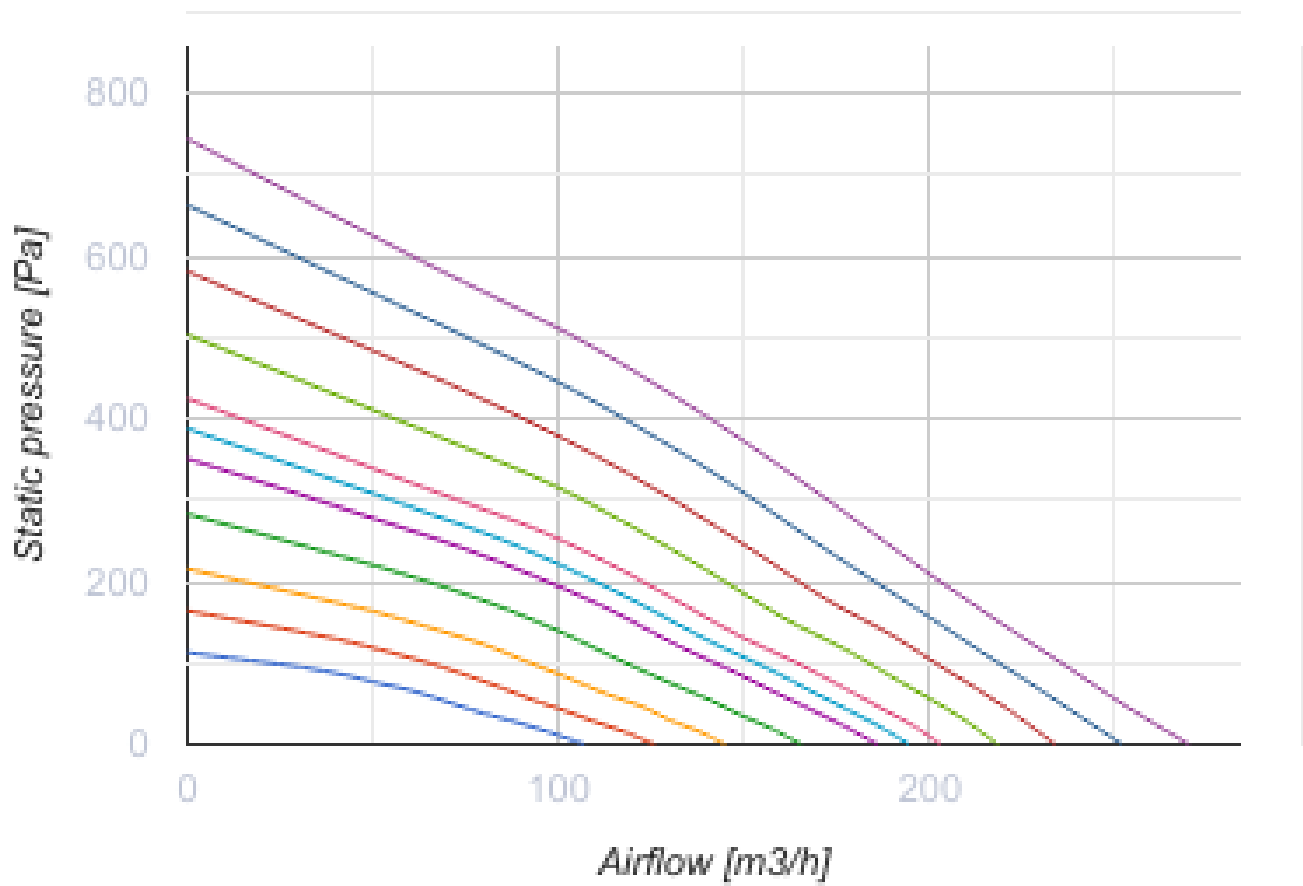

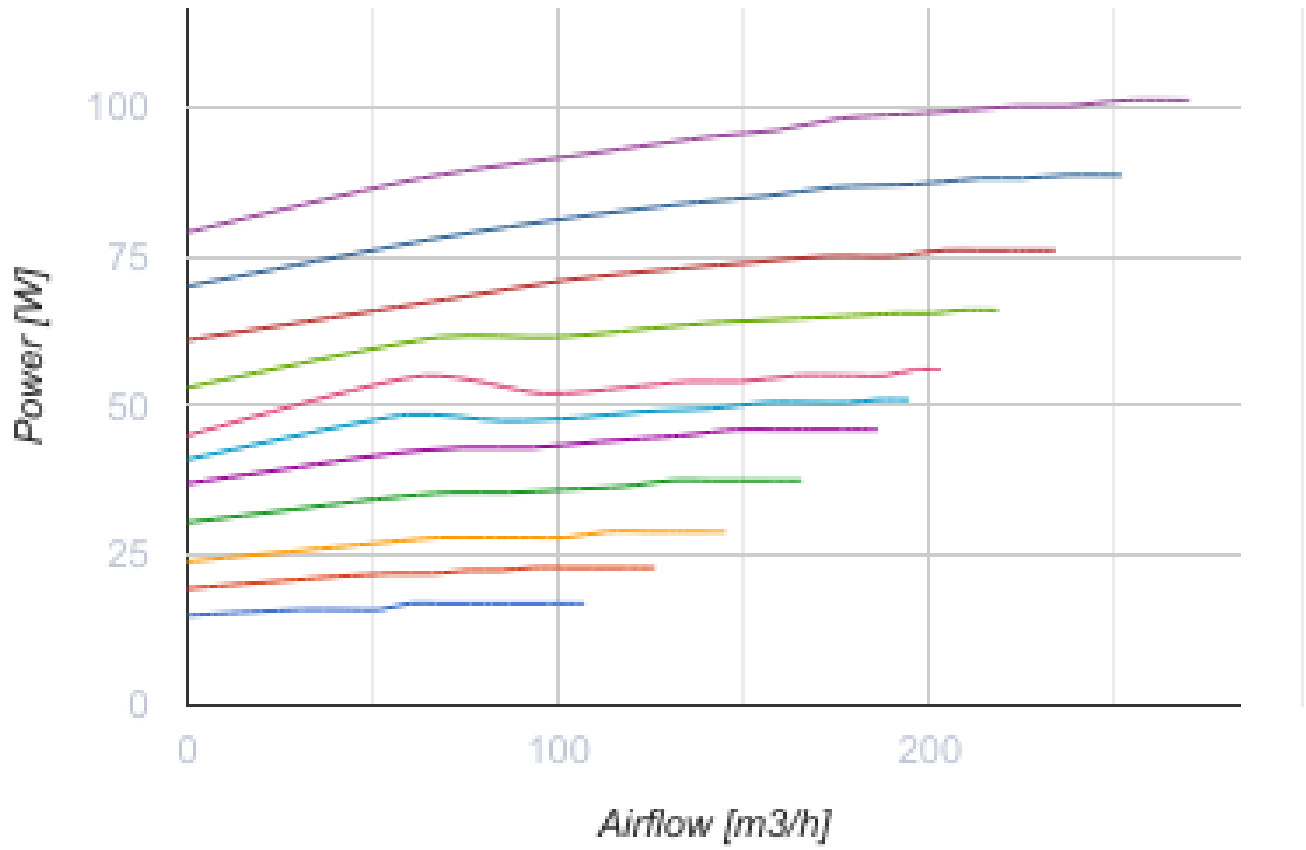

Dimensions

ØD	B	H	H1	L
125	754	320	361	1008

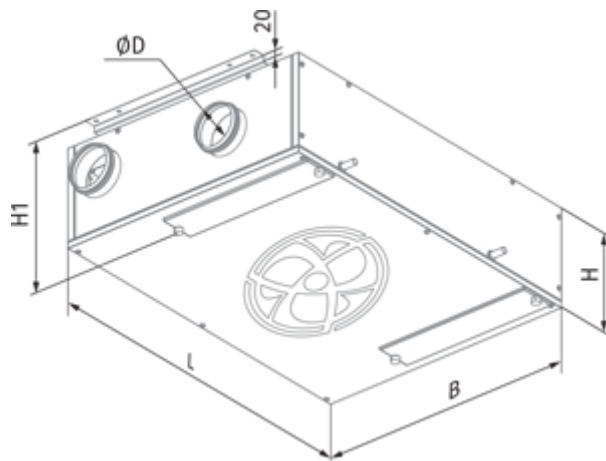

Ecodesign

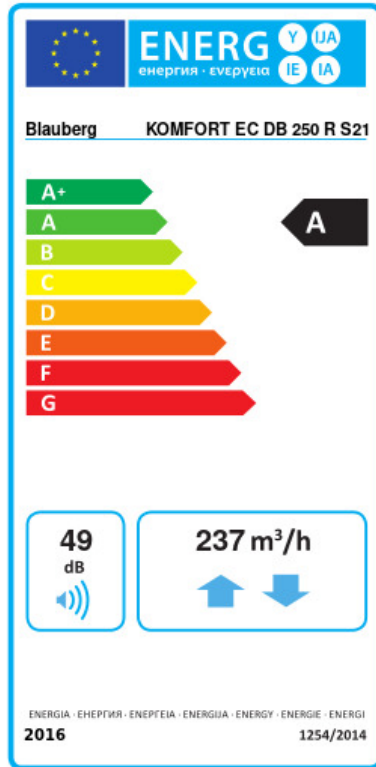

Trademark	Blauberg					
Model	KOMFORT EC DB 250 R S21					
Specific energy consumption (SEC) (kWh/(m ² /a))	Cold		Average		Warm	
	78.9	A+	41	A	15.2	E
Type of ventilation unit	Bidirectional					
Type of drive installed	Variable speed					
Type of heat recovery system	Recuperative					
Thermal efficiency of heat recovery (%)	82					
Maximum flow rate (m ³ /h)	237					
Electric power input (W)	100					
Reference flow rate (m ³ /s)	0.052					
Reference pressure difference (Pa)	50					
Specific power input (SPI) (W/(m ³ /h))	0.293					
Control typology	Local demand control					
Maximum internal leakage rates (%)	2.7					
Maximum external leakage rates (%)	2.7					
Sound power level (dB(A))	49					
Declared typology	RVU BVU					
The annual electricity consumption (AEC) (kWh/a)	Cold		Average		Warm	
	737		200		155	
The annual heating saved (AHS) (kWh/a)	Cold		Average		Warm	
	8261		4223		1909	



Accessories

Other accessories



Name	Photo	Description
FP 403x253x48 G4		G4 panel filter

FP 403x253x48 F7		F7 panel filter
------------------	---	-----------------



Other accessories



Name	Photo	Description
S22		Control panels
S22 Wi-Fi		Control panels
S25		LCD control panel

Other accessories

Name	Photo	Description
FS2		Humidity sensor
CD-1		CO2 sensors
CD-2		CO2 sensors

Other accessories



Name	Photo	Description
EVH 125-0.6-1 S21 V.2		Electric duct preheater for heat exchanger freeze protection
EVH 125-0.8-1 S21 V.2		Electric duct preheater for heat exchanger freeze protection
EVH 125-1.2-1 S21 V.2		Electric duct preheater for heat exchanger freeze protection

ENH 125-0.6-1 S21 V.2		Duct heater for supply air reheating
ENH 125-0.8-1 S21 V.2		Duct heater for supply air reheating
ENH 125-1.2-1 S21 V.2		Duct heater for supply air reheating

Other accessories

Name	Photo	Description
SFK 20x32		Hydraulic syphon for condensate drainage

Other accessories

Name	Photo	Description
SD 125/600		Silencers for round ducts
SD 125/900		Silencers for round ducts
SD 125/1200		Silencers for round ducts

Other accessories

Name	Photo	Description
VKA 125		Air dampers for round ducts

Other accessories

Name	Photo	Description
Belimo TF230		Electric actuators