

## Iso-VK EC 800 D

Kitchen sound-insulated inline centrifugal fans with EC motors

- Maximum airflow: 27500
- Sound pressure level LpA at 3 m: 67
- Fire resistance class: 120°C within 60 min
- Sound insulation
- Motor type: EC
- Impeller type: Centrifugal impeller with backward curved blades
- Casing material: Aluzinc
- Installation in any position

	Unit of measurement	Iso-VK EC 800 D
Connected air duct size	mm	800
Speed	-	1
Phases	-	3
Minimum supply voltage	V	400
Maximum supply voltage	V	400
Power supply frequency	Hz	50/60
Rated power	W	5500
Unit current	A	12.9
Maximum airflow	m <sup>3</sup> /h	27500
rotation speed at 50hz	-	1000
Sound pressure level LpA at 3 m	dB(A)	67
Weight	kg	275
Transported air temperature (max)	°C	120
Transported air temperature (min)	°C	-25
Ingress protection rating	-	IPX4

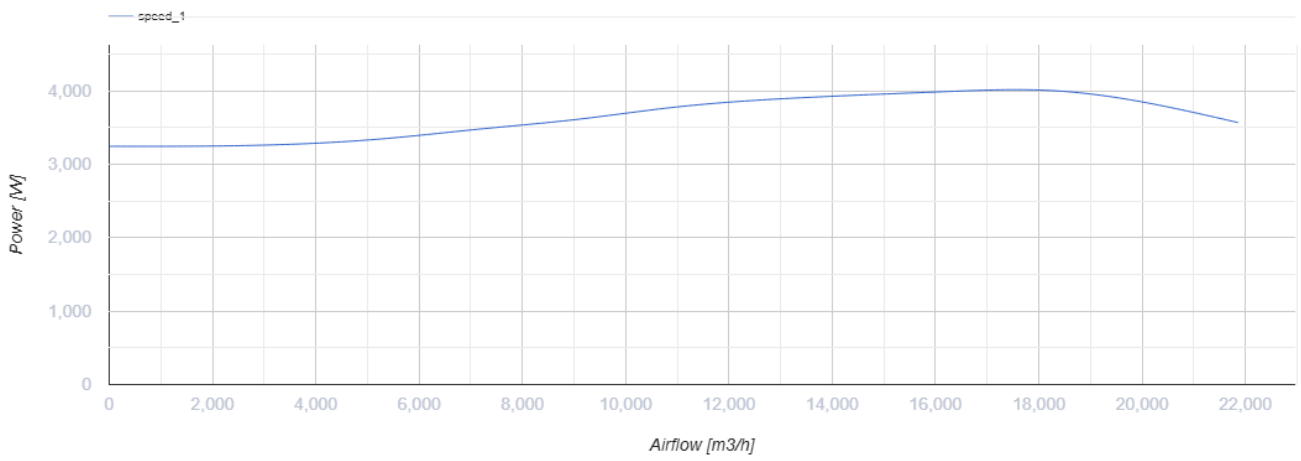
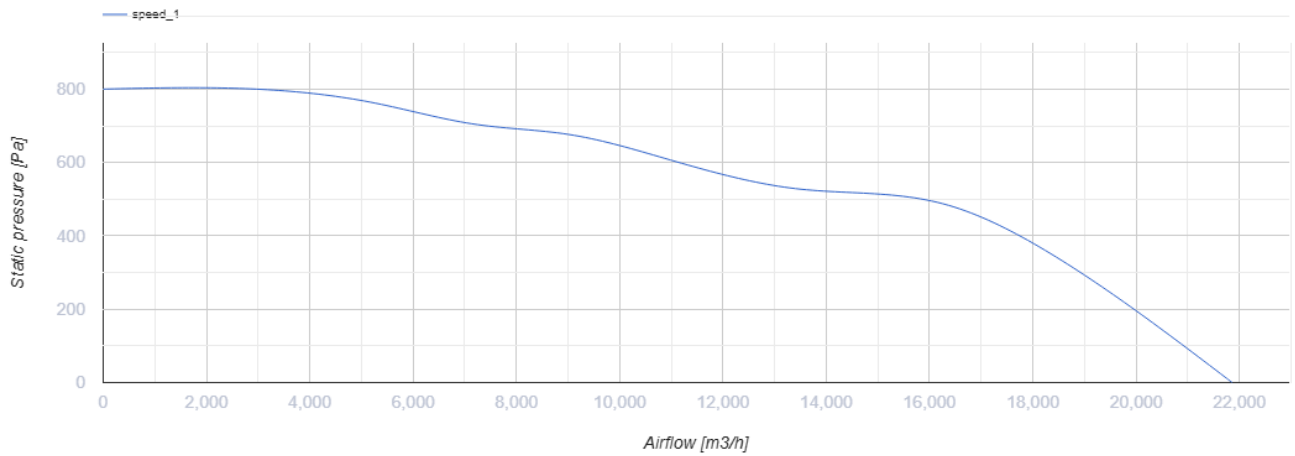

## Dimensions

H	H1	H2	L	L1	W	W1	W2
1175	1214	1115	1175	1252	1175	1212	505

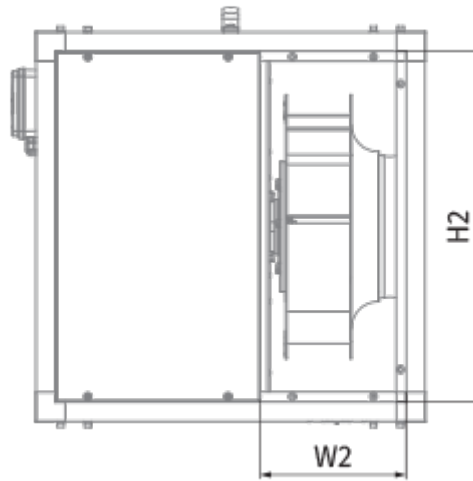
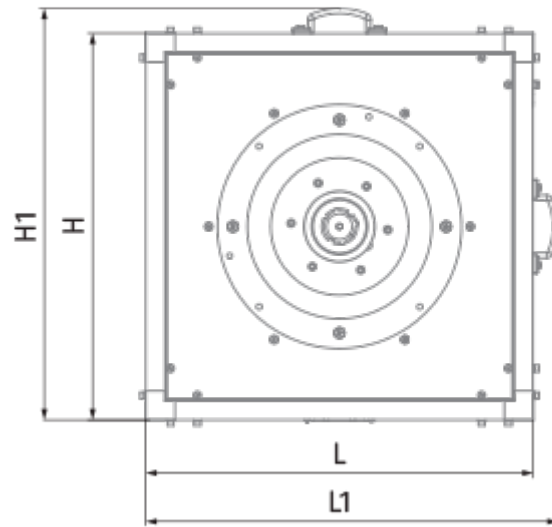

## Accessories

### EC motors regulators

Name	Photo	Description
<a href="#">CDT E/0-10</a>		Speed control for EC motors