

Iso-VK EC 560 D

Kitchen sound-insulated inline centrifugal fans with EC motors

- Maximum airflow: 15700
- Sound pressure level LpA at 3 m: 64
- Fire resistance class: 120°C within 60 min
- Sound insulation
- Motor type: EC
- Impeller type: Centrifugal impeller with backward curved blades
- Casing material: Aluzinc
- Installation in any position

	Unit of measurement	Iso-VK EC 560 D
Connected air duct size	mm	560
Speed	-	1
Phases	-	3
Minimum supply voltage	V	400
Maximum supply voltage	V	400
Power supply frequency	Hz	50/60
Rated power	W	3000
Unit current	A	6.4
Maximum airflow	m ³ /h	15700
rotation speed at 50hz	-	1500
Sound pressure level LpA at 3 m	dB(A)	64
Weight	kg	113
Transported air temperature (max)	°C	120
Transported air temperature (min)	°C	-25
Ingress protection rating	-	IPX4

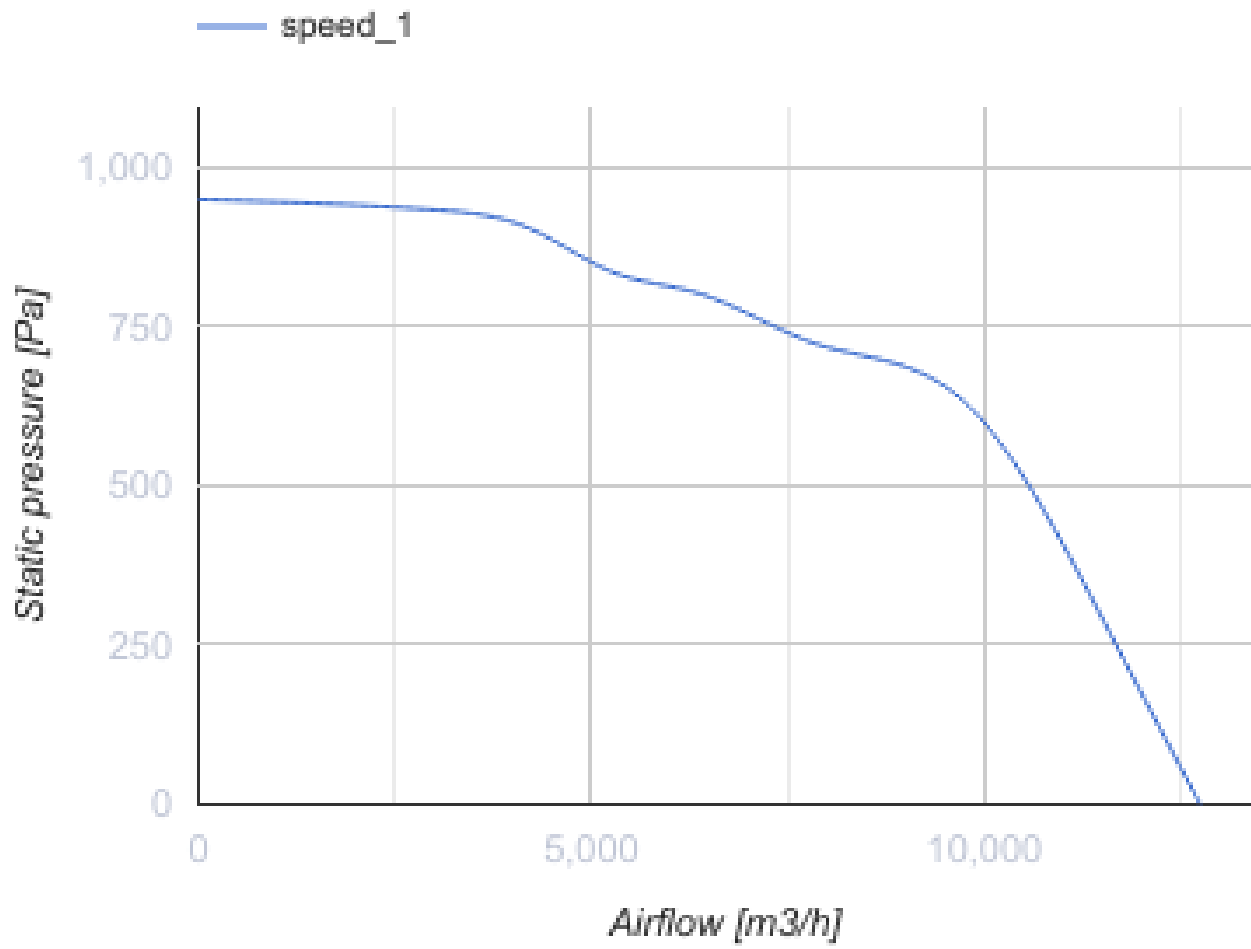

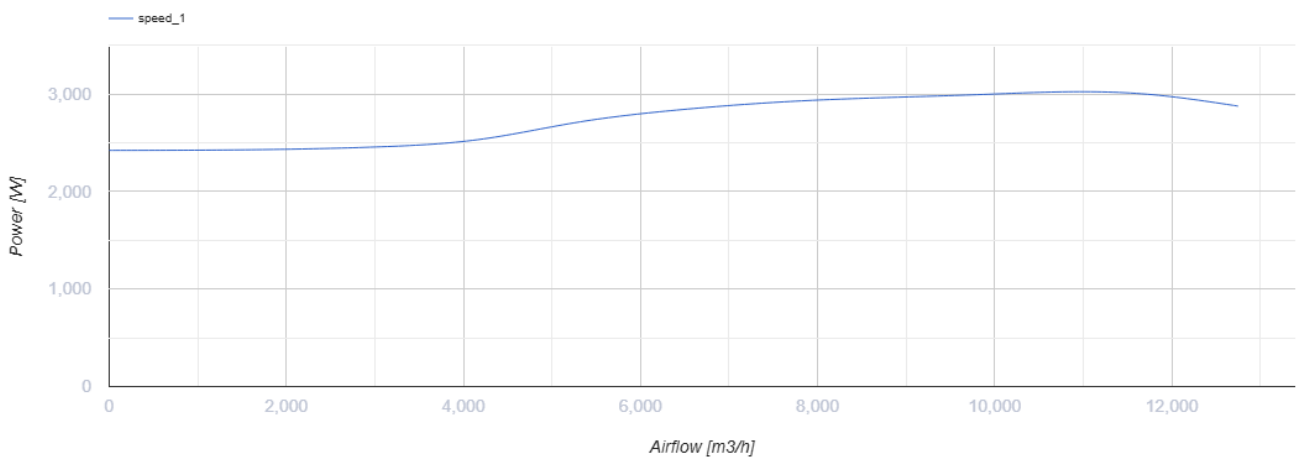
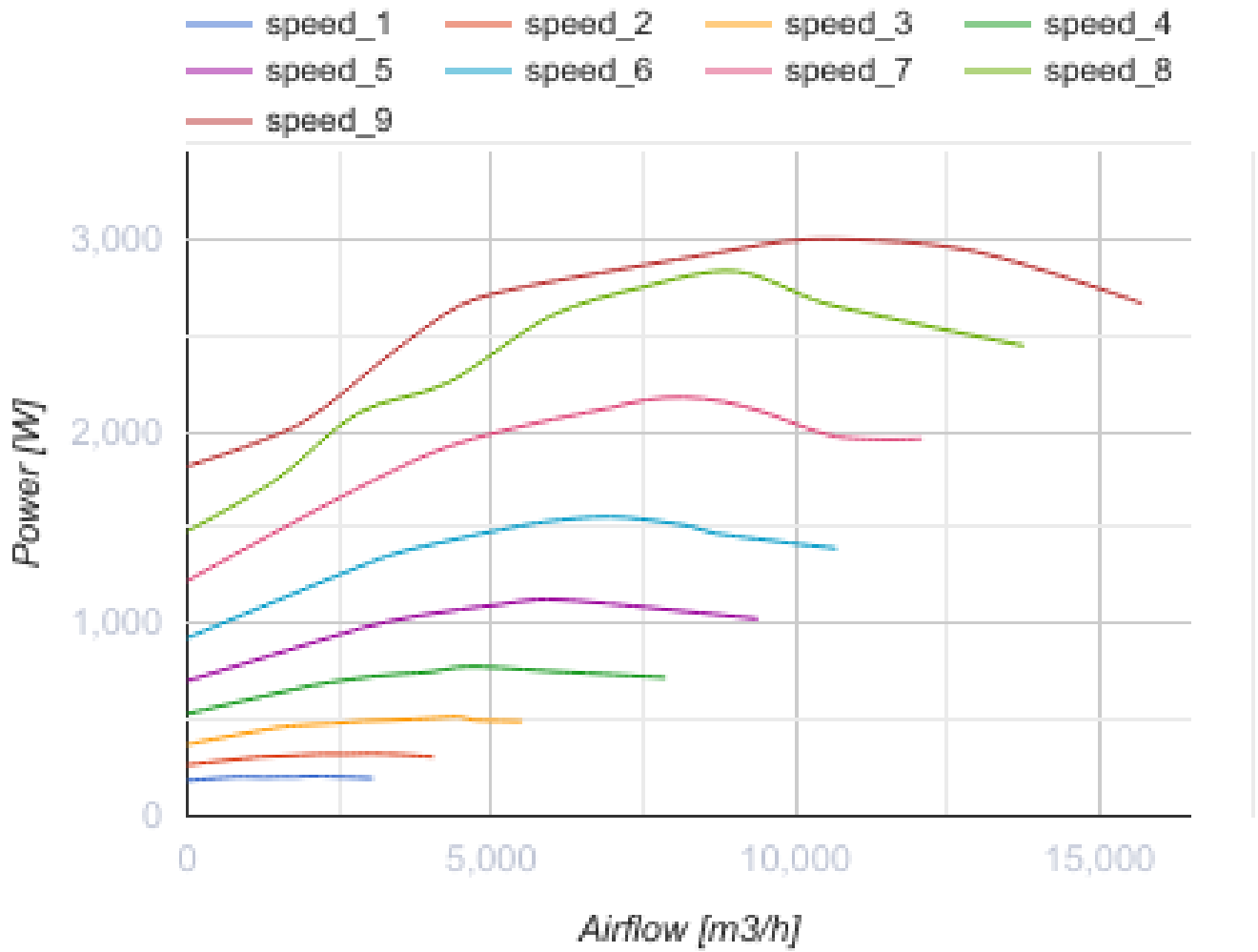

Dimensions

H	H1	H2	L	L1	W	W1	W2
900	938	840	900	938	900	938	365

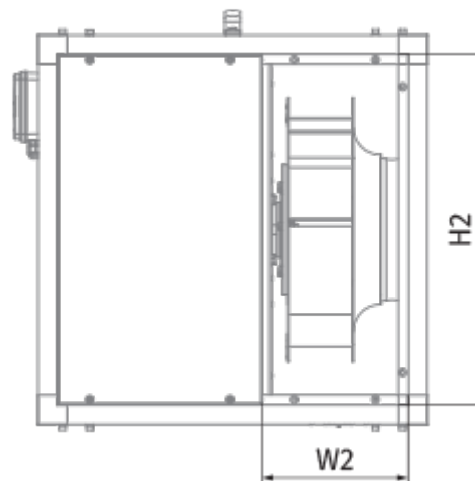
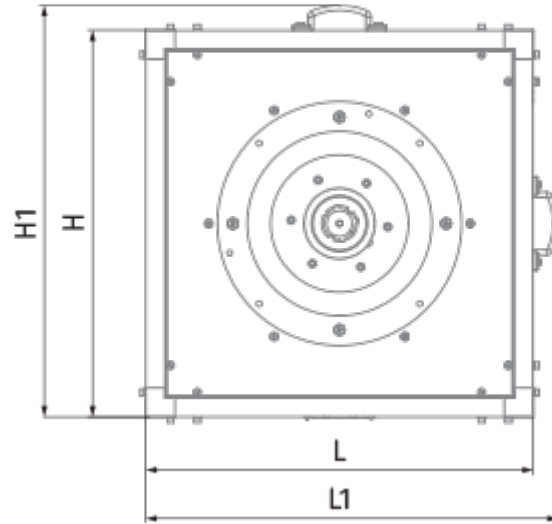

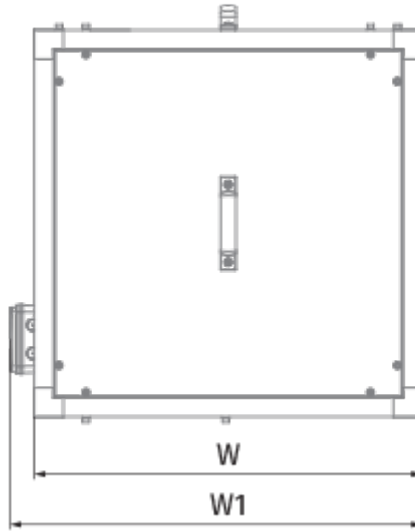

Accessories

EC motors regulators

Name	Photo	Description
CDT E/0-10		Speed control for EC motors