

Iso-VK 500 4D

Kitchen sound-insulated inline centrifugal fans with AC motors

- Maximum airflow: 9100
- Sound pressure level LpA at 3 m: 60
- Sound insulation
- Motor type: AC
- Impeller type: Centrifugal impeller with backward curved blades
- Casing material: Aluzinc
- Installation in any position

	Unit of measurement	Iso-VK 500 4D
Connected air duct size	mm	500
Speed	-	1
Phases	-	3
Minimum supply voltage	V	400
Maximum supply voltage	V	400
Power supply frequency	Hz	50
Rated power	W	1500
Unit current	A	3.4
Maximum airflow	m ³ /h	9100
rotation speed at 50hz	-	1450
Sound pressure level LpA at 3 m	dB(A)	60
Weight	kg	101.8
Transported air temperature (max)	°C	120
Transported air temperature (min)	°C	-25
Ingress protection rating	-	IPX4

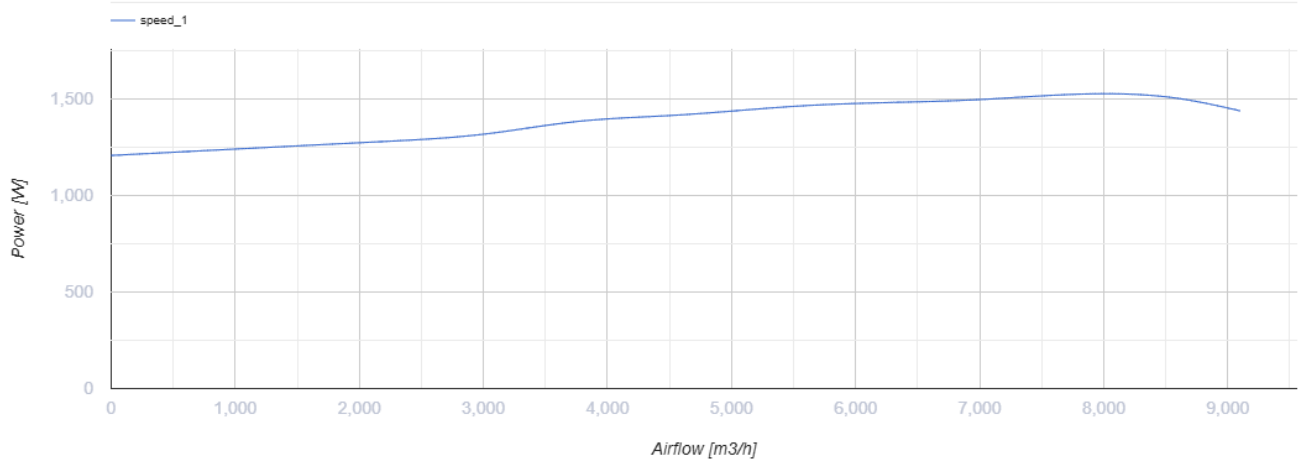
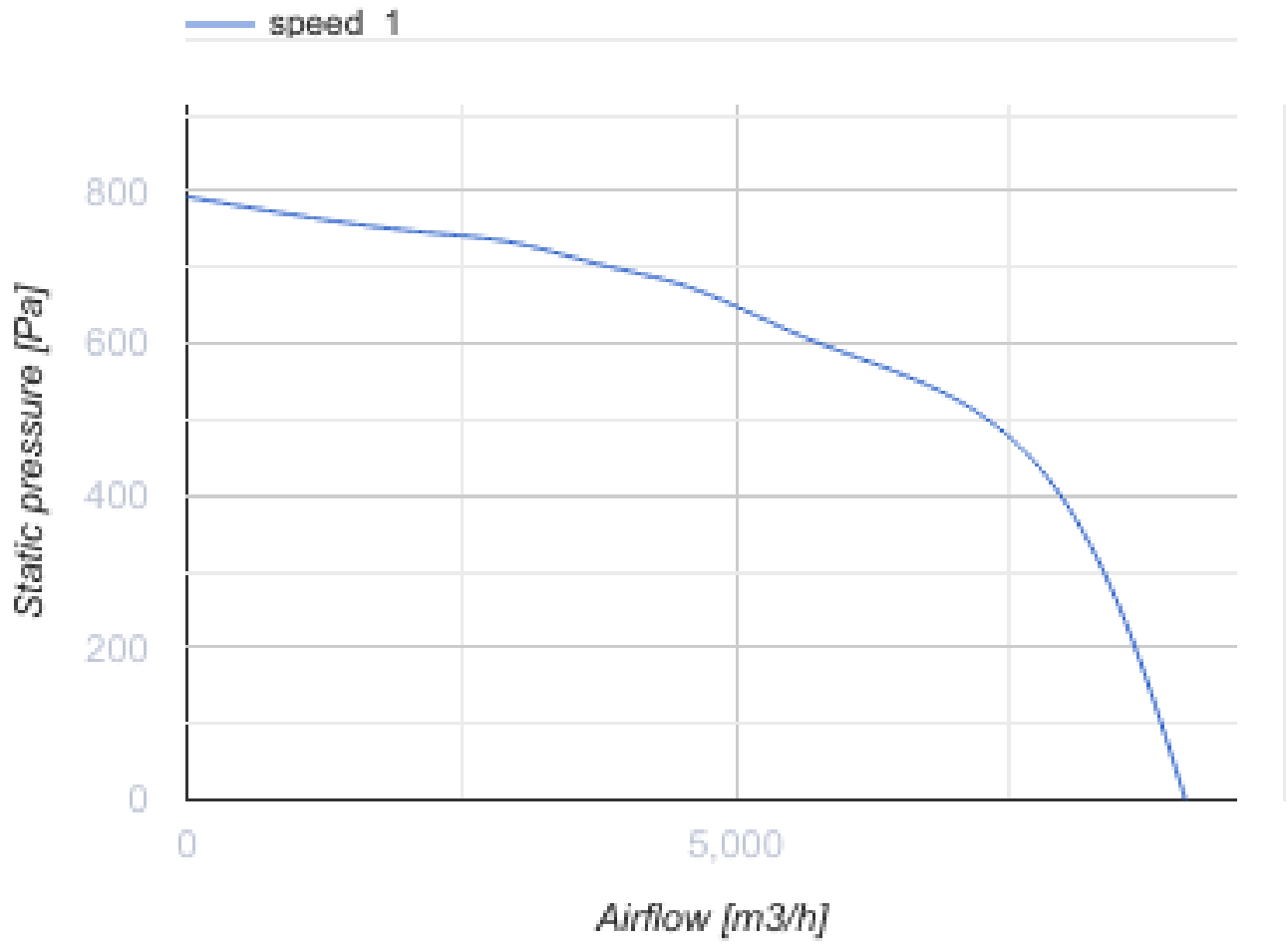

Dimensions

H	H1	H2	L	L1	W	W1	W2
820	858	760	820	858	820	858	321

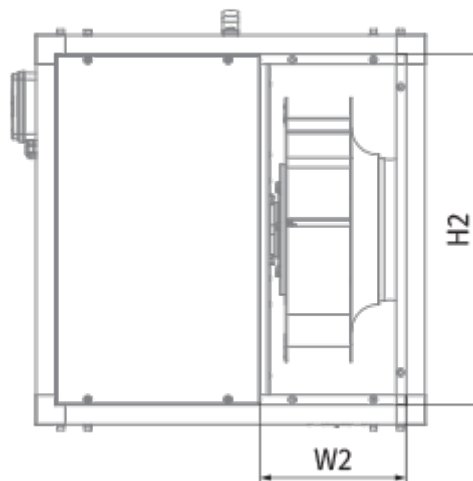
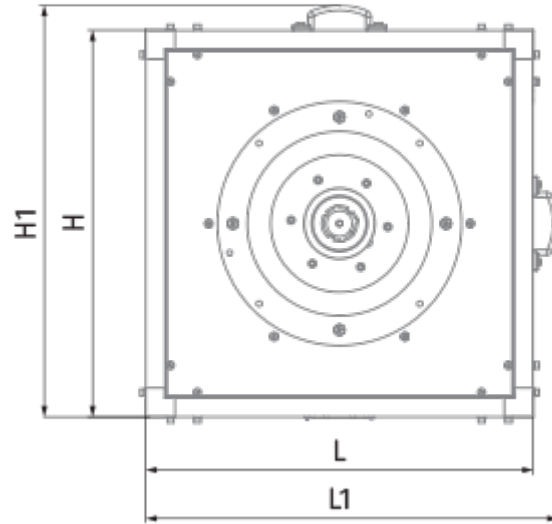

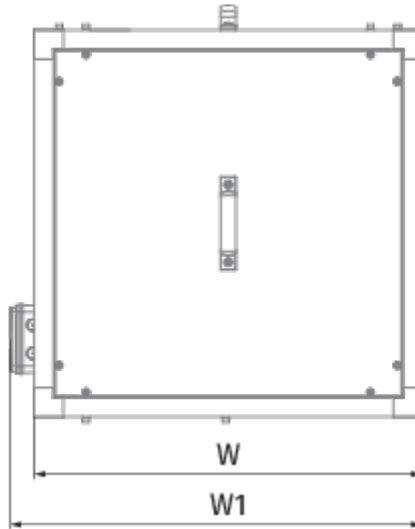

Accessories

Thyristor speed controllers

Name	Photo	Description
CDT E1.8		Thyristor speed controller