

## Iso-VK 315 4E

Kitchen sound-insulated inline centrifugal fans with AC motors

- Maximum airflow: 1910
- Sound pressure level LpA at 3 m: 48
- Sound insulation
- Motor type: AC
- Impeller type: Centrifugal impeller with backward curved blades
- Casing material: Aluzinc
- Installation in any position

	Unit of measurement	Iso-VK 315 4E
Connected air duct size	mm	315
Speed	-	1
Phases	-	1
Minimum supply voltage	V	230
Maximum supply voltage	V	230
Power supply frequency	Hz	50
Rated power	W	250
Unit current	A	2.16
Maximum airflow	m <sup>3</sup> /h	1910
rotation speed at 50hz	-	1320
Sound pressure level LpA at 3 m	dB(A)	48
Weight	kg	37.2
Transported air temperature (max)	°C	120
Transported air temperature (min)	°C	-25
Ingress protection rating	-	IPX4

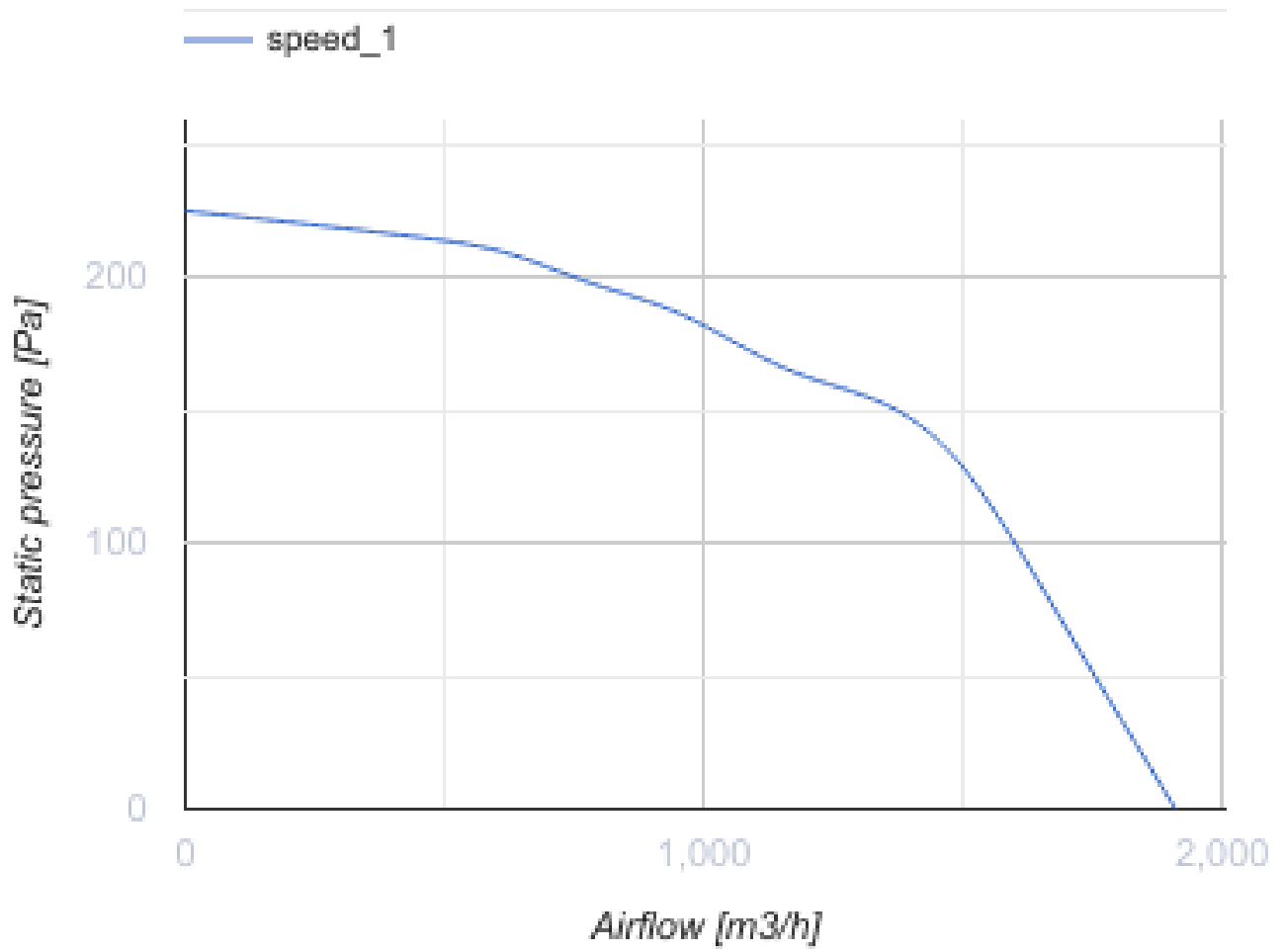

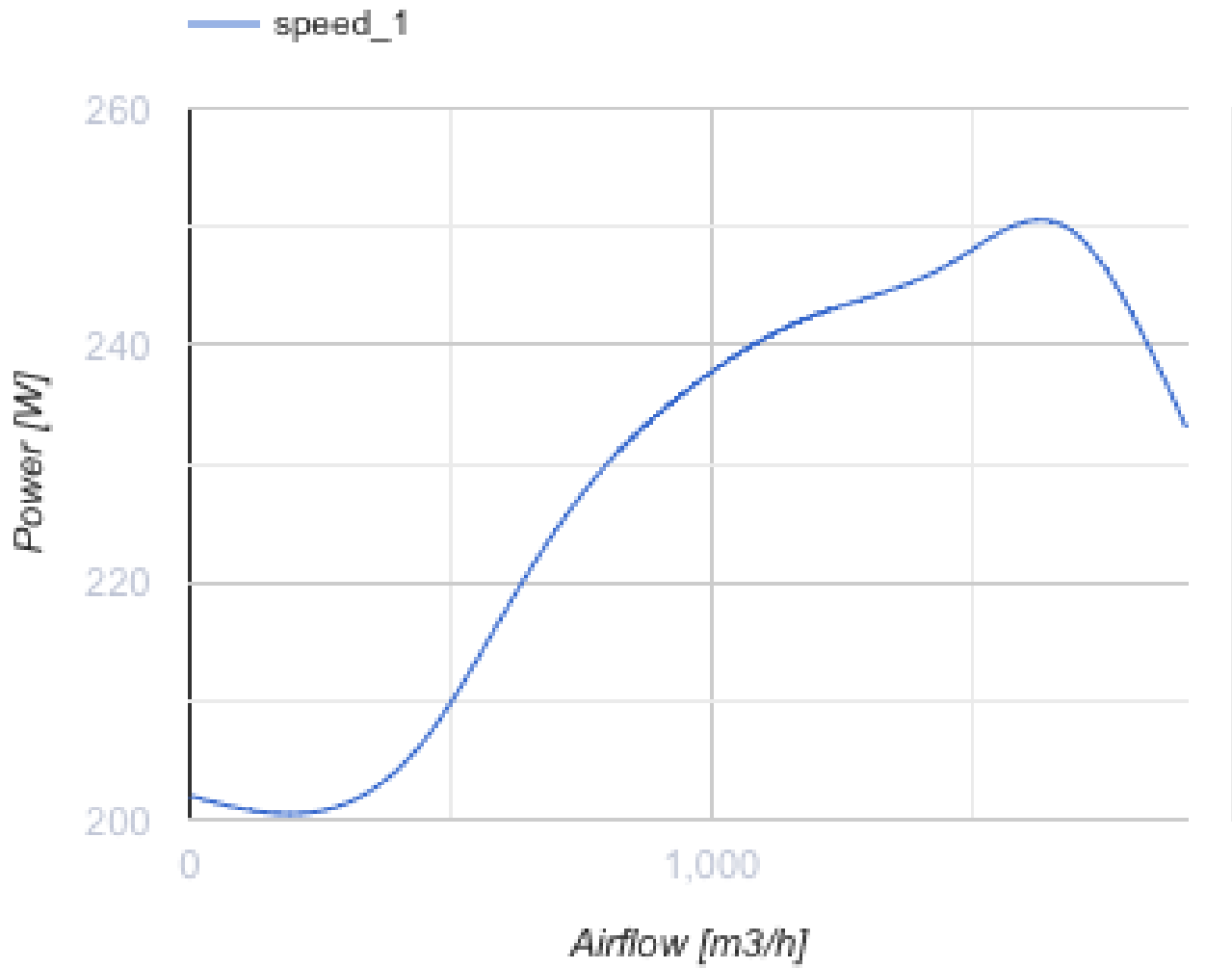

## Dimensions

H	H1	H2	L	L1	W	W1	W2
500	538	440	500	538	500	538	200

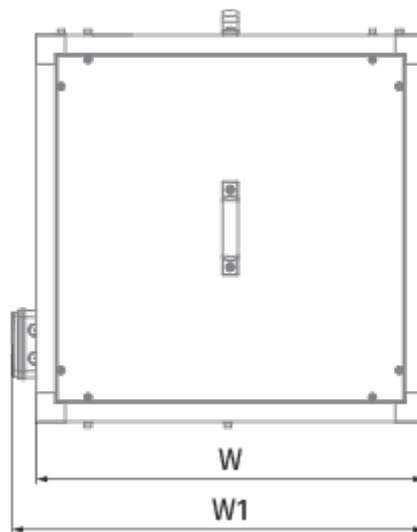
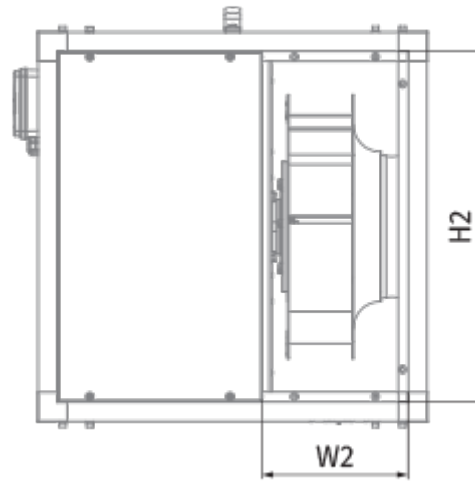
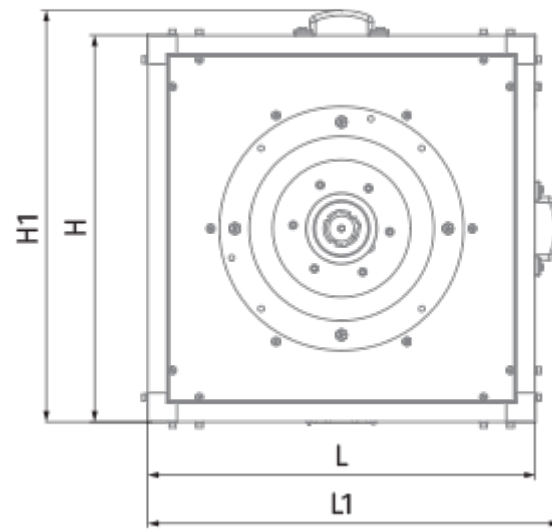

## Accessories

### Thyristor speed controllers

Name	Photo	Description
<a href="#">CDT E1.8</a>		Thyristor speed controller