

Iso-V EC 450

Sound-insulated inline fans with EC motor



- Maximum airflow: 6800
- Sound pressure level LpA at 3 m: 50
- Sound insulation
- Motor type: EC
- Impeller type: Centrifugal backward curved blades
- Casing material: Aluzinc
- Installation in any position

	Unit of measurement	Iso-V EC 450
Connected air duct size	mm	450
Speed	-	1
Minimum supply voltage	V	200
Maximum supply voltage	V	277
Power supply frequency	Hz	50/60
Rated power	W	750
Unit current	A	3.3
Maximum airflow	m ³ /h	6800
Sound pressure level LpA at 3 m	dB(A)	50
Weight	kg	46.3
Transported air temperature (max)	°C	60
Transported air temperature (min)	°C	-25
Ingress protection rating	-	IPX4

Dimensions

A
670

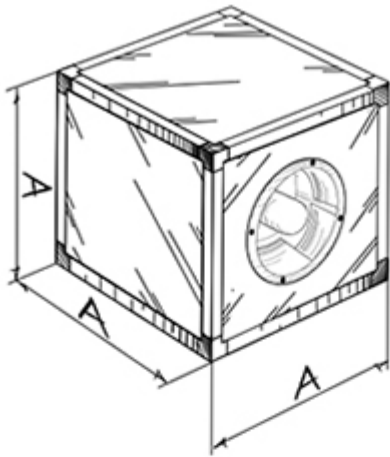

Iso-V EC

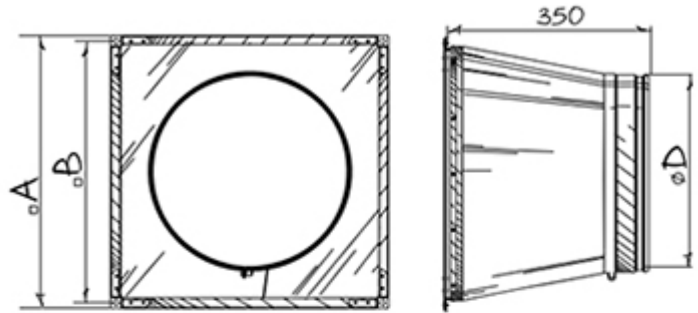

ARV

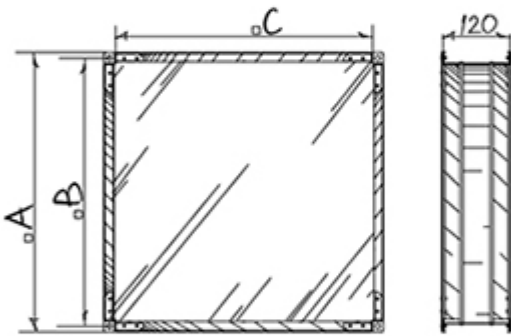

AKV

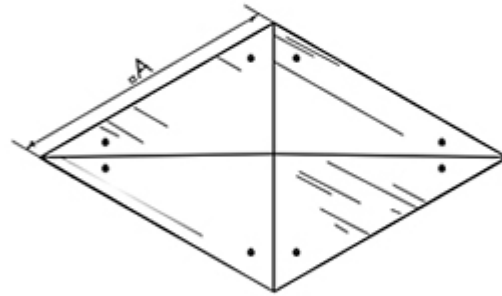

RSD-IV

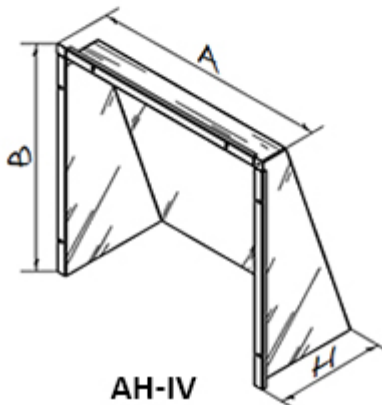

AH-IV

Ecodesign

Trademark	Blauberg
Model	Iso-V EC 450
Type of ventilation unit	Unidirectional
Type of drive installed	Integrated VSD
Type of heat recovery system	None
Nominal flow rate (m ³ /s)	1.165
Nominal external pressure (Pa)	405
Maximum external leakage rates (%)	2.7
Static efficiency (%)	70.4
Declared typology	NRVU UVU
Sound power level (dB(A))	70
Effective electric power input (kW)	0.75

Accessories

EC motors regulators

Name	Photo	Description
CDT E/0-10		Speed control for EC motors