

Iso-V EC 400

Sound-insulated inline fans with EC motor



- Maximum airflow: 5660
- Sound pressure level LpA at 3 m: 39
- Sound insulation
- Motor type: EC
- Impeller type: Centrifugal backward curved blades
- Casing material: Aluzinc
- Installation in any position

	Unit of measurement	Iso-V EC 400
Connected air duct size	mm	400
Speed	-	1
Minimum supply voltage	V	200
Maximum supply voltage	V	277
Power supply frequency	Hz	50/60
Rated power	W	500
Unit current	A	2.2
Maximum airflow	m ³ /h	5660
Sound pressure level LpA at 3 m	dB(A)	39
Weight	kg	42.2
Transported air temperature (max)	°C	50
Transported air temperature (min)	°C	-25
Ingress protection rating	-	IPX4

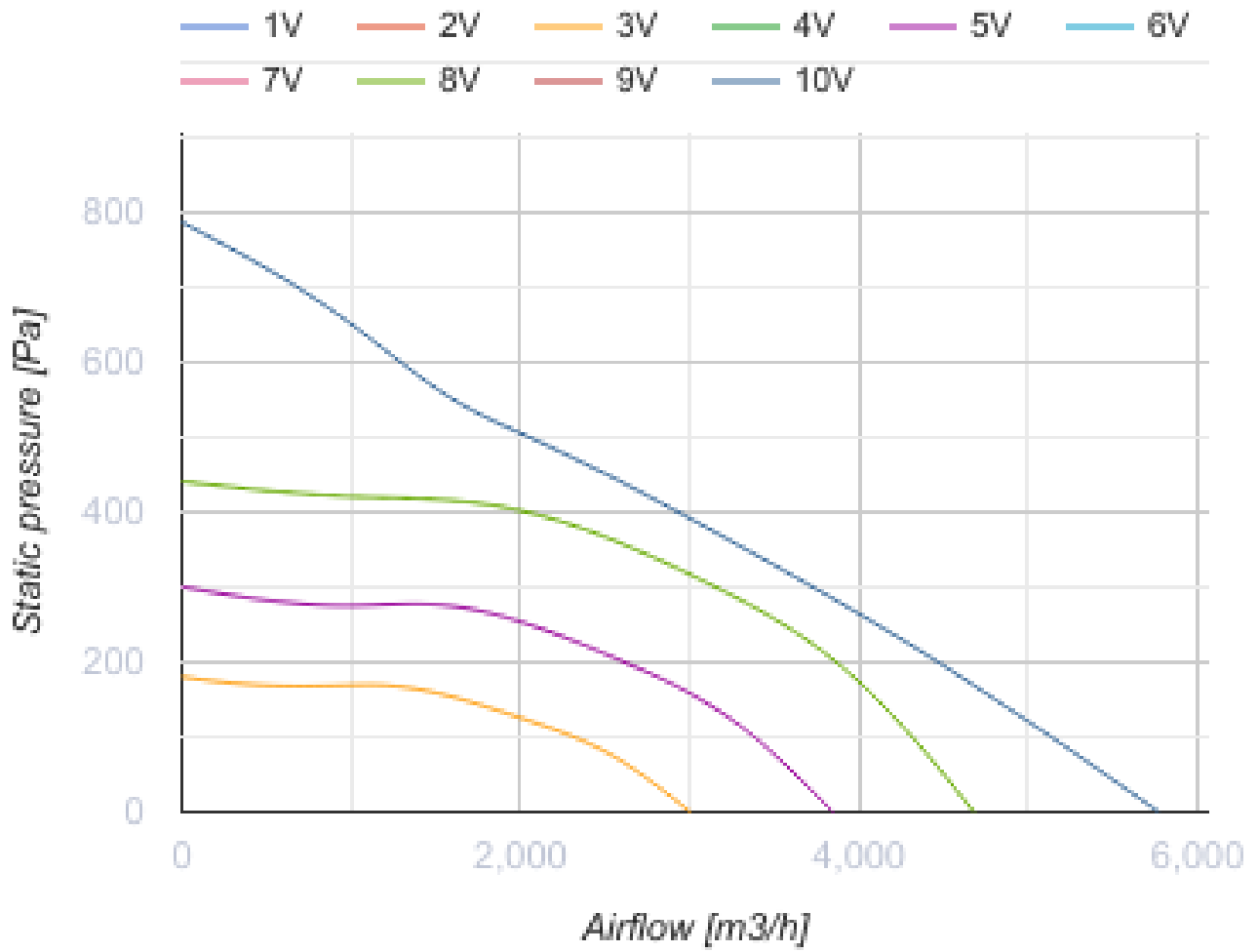

Dimensions

A
670

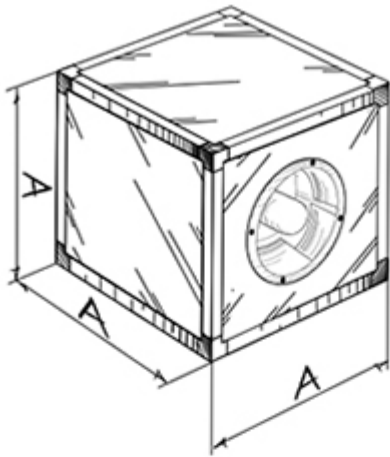

Iso-V EC

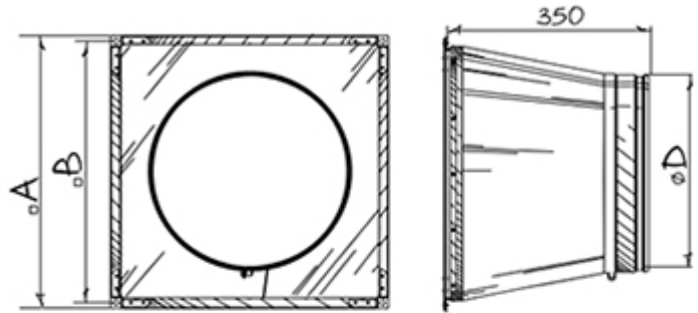

ARV

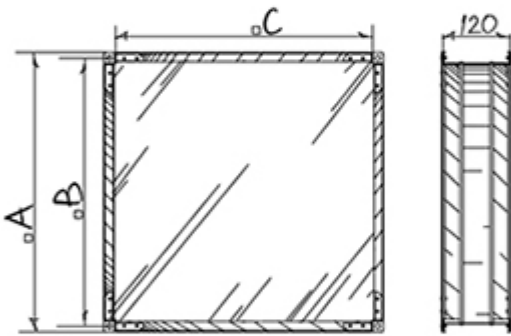

AKV

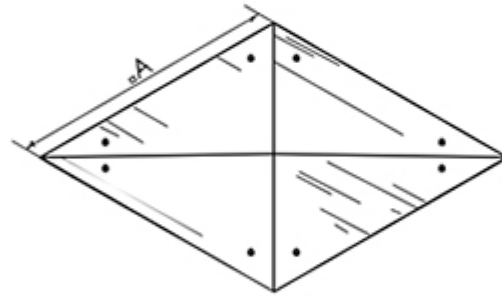

RSD-IV

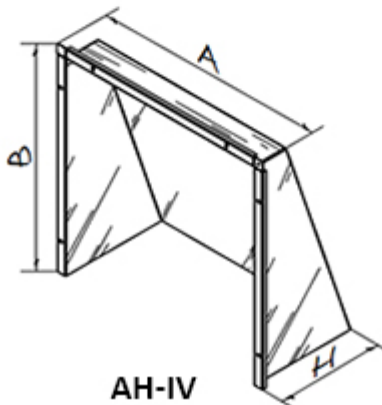

AH-IV

Ecodesign

Trademark	Blauberg
Model	Iso-V EC 400
Type of ventilation unit	Unidirectional
Type of drive installed	Integrated VSD
Type of heat recovery system	None
Nominal flow rate (m ³ /s)	0.711
Nominal external pressure (Pa)	403
Maximum external leakage rates (%)	2.7
Static efficiency (%)	64.8
Declared typology	NRVU UVU
Sound power level (dB(A))	59
Effective electric power input (kW)	0.5

Accessories

EC motors regulators

Name	Photo	Description
CDT E/0-10		Speed control for EC motors