



Iso-V 560 6D

Sound-insulated inline centrifugal fans

- Maximum airflow: 7970
- Sound pressure level LpA at 3 m: 49
- Sound insulation
- Motor type: AC
- Impeller type: Centrifugal backward curved blades
- Casing material: Aluzinc
- Installation in any position

	Unit of measurement	Iso-V 560 6D
Connected air duct size	mm	560
Speed	-	1
Minimum supply voltage	V	400
Maximum supply voltage	V	400
Power supply frequency	Hz	50
Rated power	W	780
Unit current	A	1.7
Maximum airflow	m ³ /h	7970
Sound pressure level LpA at 3 m	dB(A)	49
Weight	kg	86
Transported air temperature (max)	°C	55
Transported air temperature (min)	°C	-40
Ingress protection rating	-	IPX4

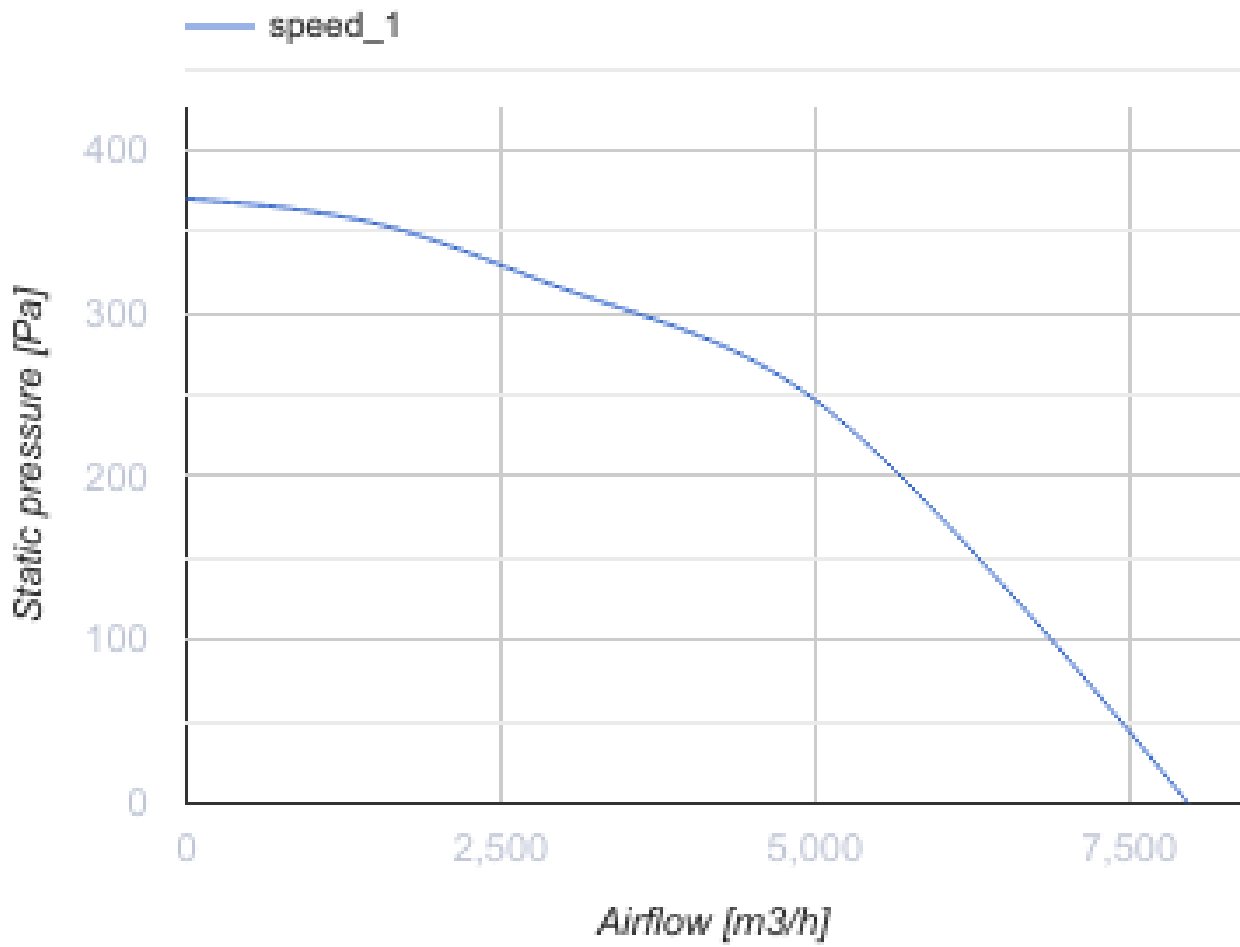

Dimensions

A
800

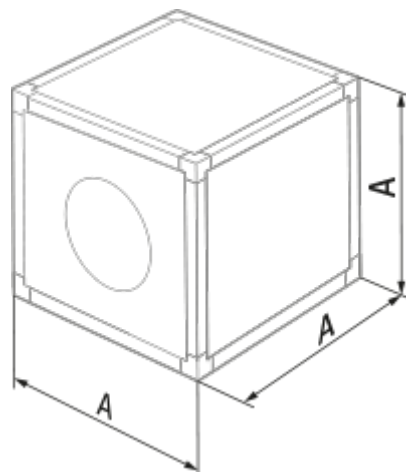

Ecodesign

Trademark	Blauberg
Model	Iso-V 560 6D
Type of ventilation unit	Unidirectional
Type of drive installed	External MSD or VSD
Type of heat recovery system	None
Nominal flow rate (m ³ /s)	1.308
Nominal external pressure (Pa)	253
Maximum external leakage rates (%)	2.7
Static efficiency (%)	45
Declared typology	NRVU UVU
Sound power level (dB(A))	69
Effective electric power input (kW)	0.751

Accessories

Thyristor speed controllers

Name	Photo	Description
CDT E1.8		Thyristor speed controller