

ISO-RB EC 450

Sound-insulated inline centrifugal fans

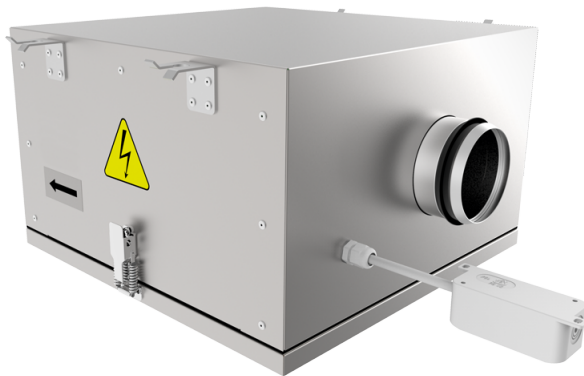

- Maximum airflow: 5620
- Sound pressure level LpA at 3 m: 54
- Sound insulation
- Motor type: EC
- Impeller type: Centrifugal backward curved blades
- Casing material: Aluzinc
- Installation in any position

	Unit of measurement	ISO-RB EC 450
Connected air duct size	mm	450
Speed	-	1
Minimum supply voltage	V	200
Maximum supply voltage	V	277
Power supply frequency	Hz	50/60
Rated power	W	1200
Unit current	A	1.95
Maximum airflow	m ³ /h	5620
Sound pressure level LpA at 3 m	dB(A)	54
Weight	kg	60
Transported air temperature (max)	°C	55
Transported air temperature (min)	°C	-25
Ingress protection rating	-	IPX4
Ingress protection rating of the drive	-	IP54

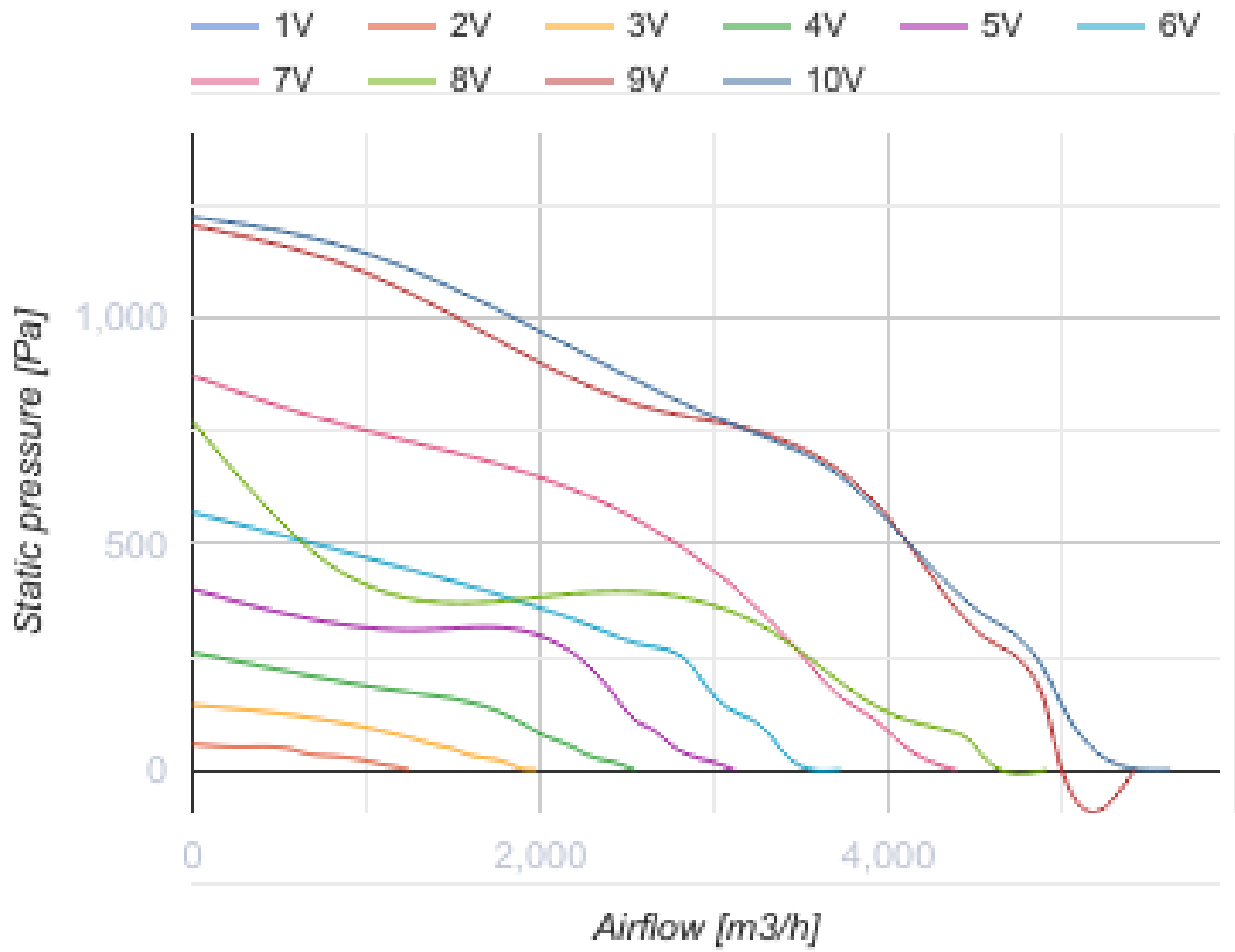

Dimensions

ØD	B	B1	B2	H	L1	L2
449	885	670	982	580	886	805

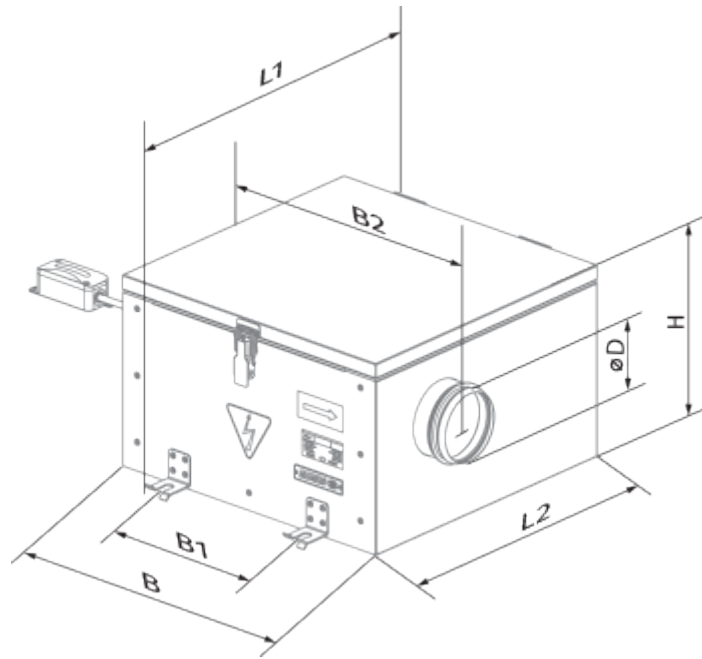

Ecodesign



Trademark	Blauberg
Model	ISO-RB EC 450
Type of ventilation unit	Unidirectional
Type of drive installed	Integrated VSD
Type of heat recovery system	None
Nominal flow rate (m ³ /s)	0.87
Nominal external pressure (Pa)	762
Maximum external leakage rates (%)	2.7
Static efficiency (%)	72.2
Declared typology	NRVU UVU
Sound power level (dB(A))	74
Effective electric power input (kW)	0.937

Accessories

EC motors regulators

Name	Photo	Description
CDT E/0-10		Speed control for EC motors

Humidity sensors

Name	Photo	Description
TE / TI 1.5		Timers
HSE / HSI 1.5		Sensors
LSE / LSI 1.5		Sensors

[IRSE / IRSI 1.5](#)



Sensors