

ISO-RB EC 160

Sound-insulated inline centrifugal fans

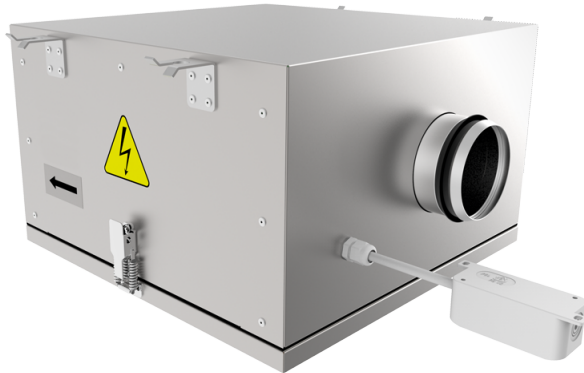

- Maximum airflow: 454
- Sound pressure level LpA at 3 m: 40
- Sound insulation
- Motor type: EC
- Impeller type: Centrifugal backward curved blades
- Casing material: Aluzinc
- Installation in any position

	Unit of measurement	ISO-RB EC 160
Connected air duct size	mm	160
Speed	-	1
Minimum supply voltage	V	230
Maximum supply voltage	V	230
Power supply frequency	Hz	50/60
Rated power	W	85
Unit current	A	0.76
Maximum airflow	m ³ /h	454
Sound pressure level LpA at 3 m	dB(A)	40
Weight	kg	12
Transported air temperature (max)	°C	55
Transported air temperature (min)	°C	-25
Ingress protection rating	-	IPX4
Ingress protection rating of the drive	-	IP55

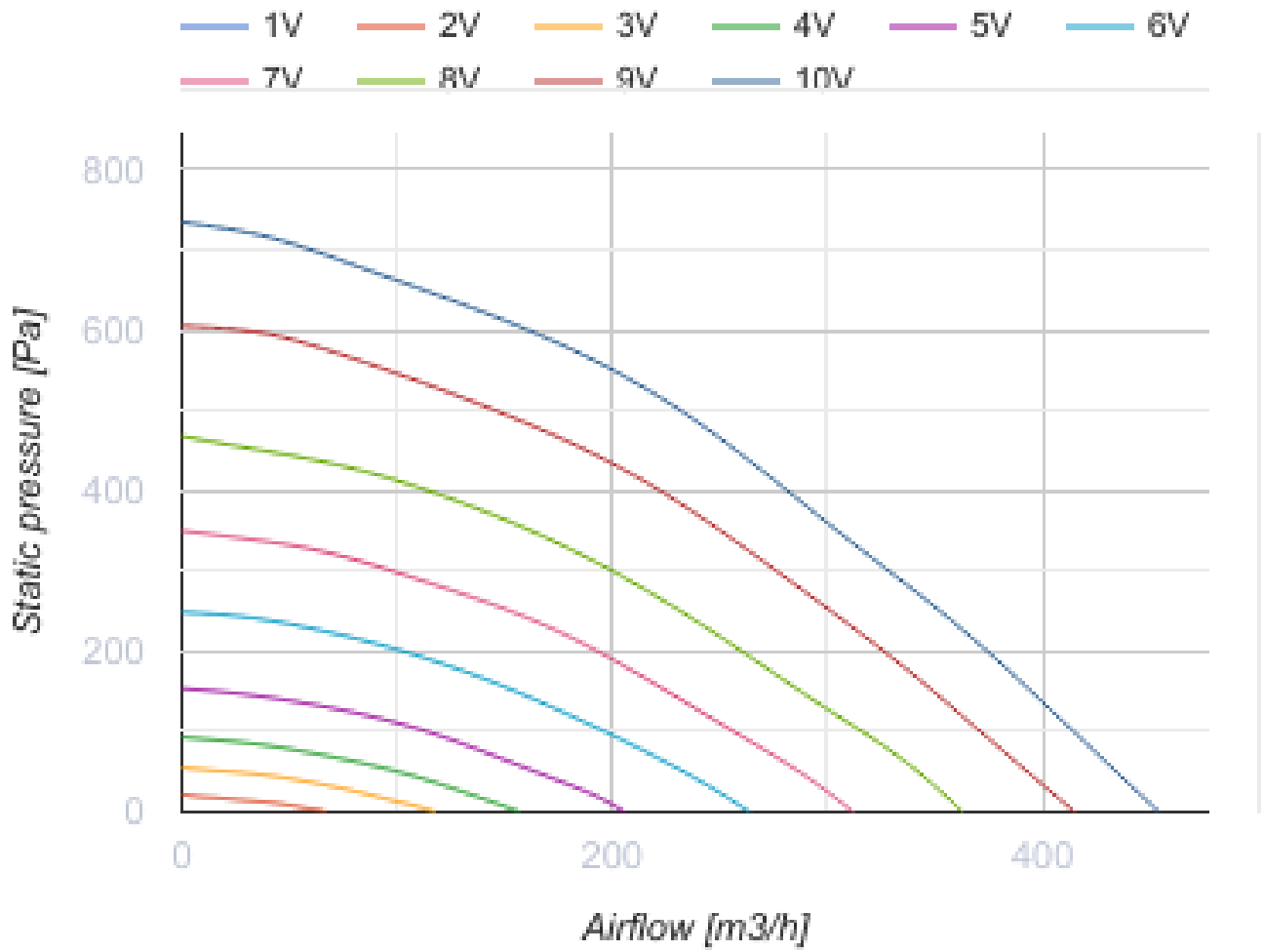

Dimensions

ØD	B	B1	B2	H	L1	L2
159	420	228	517	270	507	414

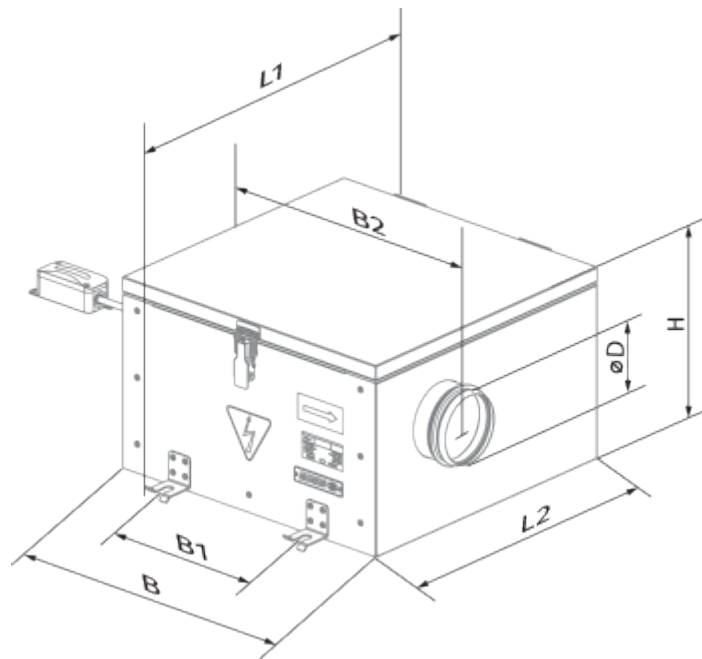

Ecodesign

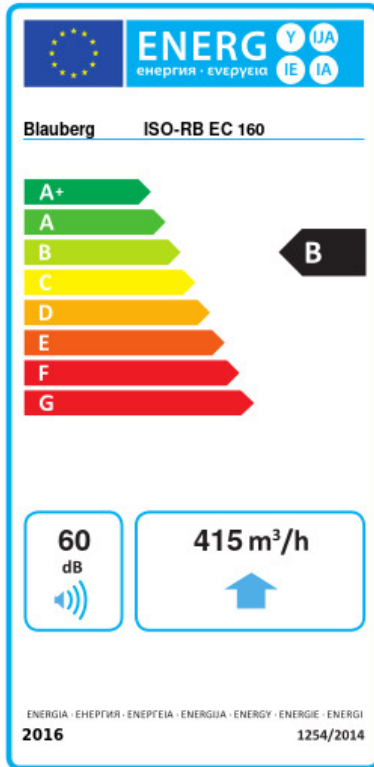

Trademark	Blauberg					
Model	ISO-RB EC 160					
Specific energy consumption (SEC) (kWh/(m ² /a))	Cold		Average		Warm	
	-53.9	A+	-26.9	B	-11.4	E
Type of ventilation unit	Unidirectional					
Type of drive installed	Variable speed					
Type of heat recovery system	None					
Maximum flow rate (m ³ /h)	415					
Electric power input (W)	93.4					
Reference flow rate (m ³ /s)	0.081					
Reference pressure difference (Pa)	50					
Specific power input (SPI) (W/(m ³ /h))	0.108					
Control typology	Local demand control					
Maximum external leakage rates (%)	2.7					
Declared typology	RVU UVU					
Sound power level (dB(A))	60					
The annual electricity consumption (AEC) (kWh/a)	Cold		Average		Warm	
	57		57		57	
The annual heating saved (AHS) (kWh/a)	Cold		Average		Warm	
	5536		2830		1280	



Accessories

EC motors regulators

Name	Photo	Description
CDT E/0-10		Speed control for EC motors

Humidity sensors

Name	Photo	Description
LSE / LSI 1.5		Sensors

TE / TI 1.5		Timers
HSE / HSI 1.5		Sensors
IRSE / IRSI 1.5		Sensors