

Iso-RB 500 (Y)

Sound-insulated inline centrifugal fans

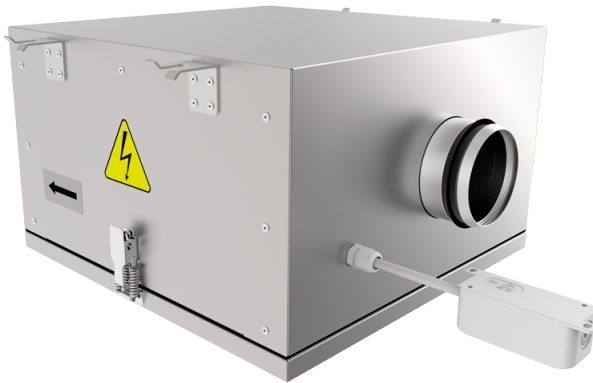

- Maximum airflow: 6720
- Sound pressure level LpA at 3 m: 54
- Sound insulation
- Motor type: AC
- Impeller type: Centrifugal backward curved blades
- Casing material: Aluzinc
- Installation in any position

	Unit of measurement	Iso-RB 500 (Y)
Connected air duct size	mm	500
Speed	-	1
Phases	-	3
Connection type	-	Y
Minimum supply voltage	V	400
Maximum supply voltage	V	400
Power supply frequency	Hz	50
Rated power	W	780
Unit current	A	1.6
Maximum airflow	m ³ /h	6720
rotation speed at 50hz	-	948
Sound pressure level LpA at 3 m	dB(A)	54
Weight	kg	129
Transported air temperature (max)	°C	55
Transported air temperature (min)	°C	-25
Ingress protection rating	-	IPX4
Ingress protection rating of the drive	-	IP54

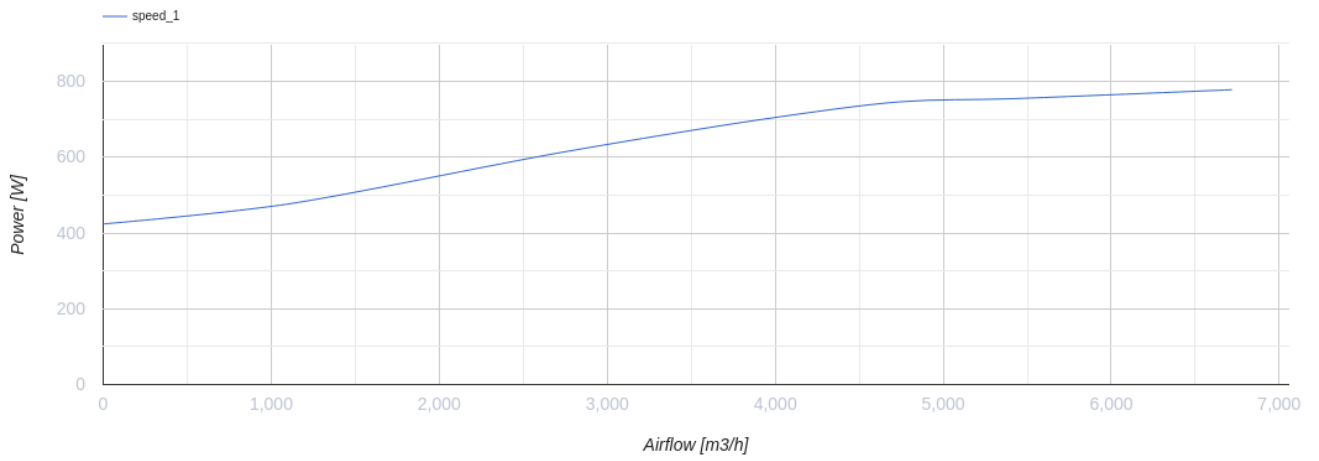
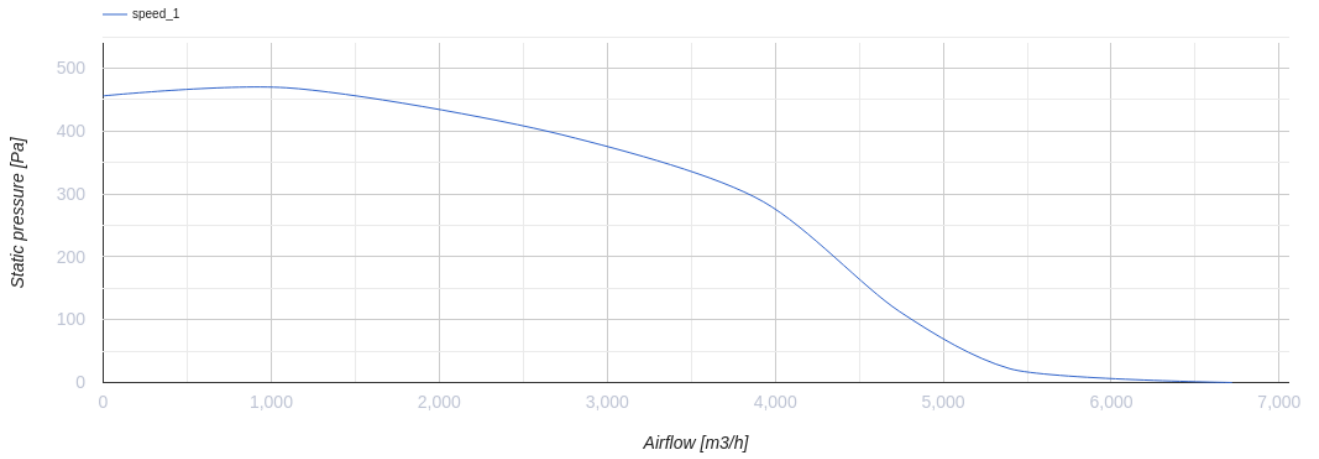



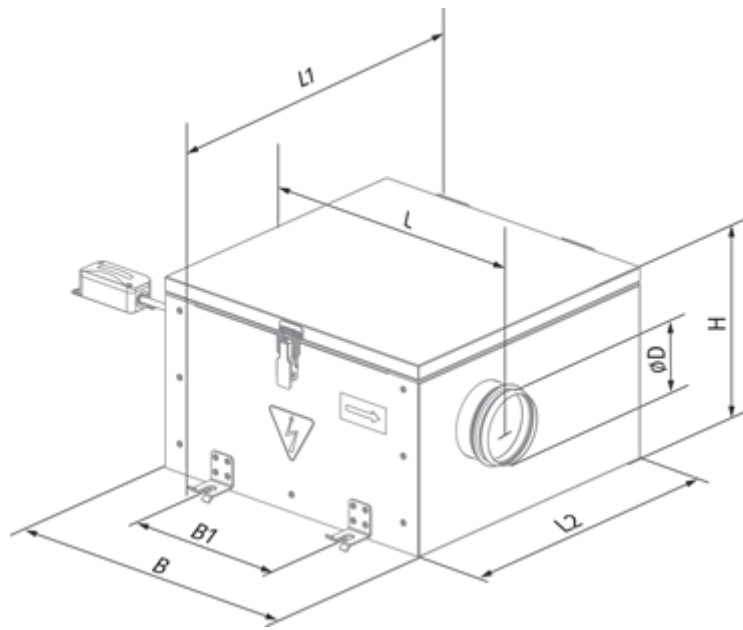

Dimensions

Ø D	B	B1	H	L	L1	L2
499	1203	993	744	1300	1263	1182





Accessories

Other accessories

Name	Photo	Description
CDT E1.8		Thyristor speed controller
CDTE E10.0 TP		Speed controllers
CDTE E5.0 TP		Speed controllers
CDTE E3.0 TP		Speed controllers

Other accessories

Name	Photo	Description
TE / TI 1.5		Timers
HSE / HSI 1.5		Sensors
LSE / LSI 1.5		Sensors

[IRSE / IRSI 1.5](#)



Sensors