

Iso-RB 500 (Δ)

Centrifugal inline fans with backward curved blades in cases with improved sound insulation properties

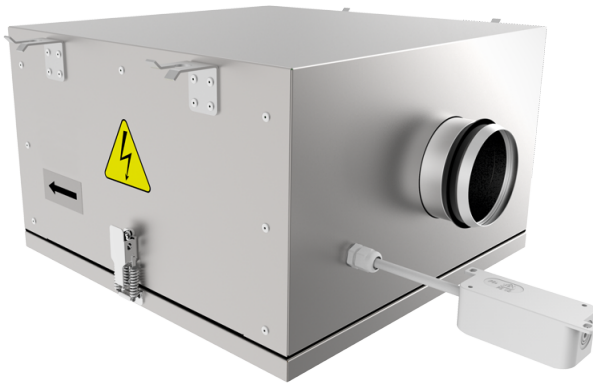

- Maximum airflow: 7000
- Sound pressure level LpA at 3 m: 56
- Sound insulation
- Motor type: AC
- Impeller type: Centrifugal backward curved blades
- Casing material: Aluzinc
- Installation in any position

	Unit of measurement	Iso-RB 500 (Δ)
Connected air duct size	mm	500
Speed	-	1
Phases	-	1
Connection type	-	Δ
Minimum supply voltage	V	230
Maximum supply voltage	V	230
Power supply frequency	Hz	50
Rated power	W	730
Unit current	A	2.82
Maximum airflow	m ³ /h	7000
rotation speed at 50hz	-	980
Sound pressure level LpA at 3 m	dB(A)	56
Weight	kg	129
Transported air temperature (max)	°C	55
Transported air temperature (min)	°C	-25
Ingress protection rating	-	IPX4
Ingress protection rating of the drive	-	IP54

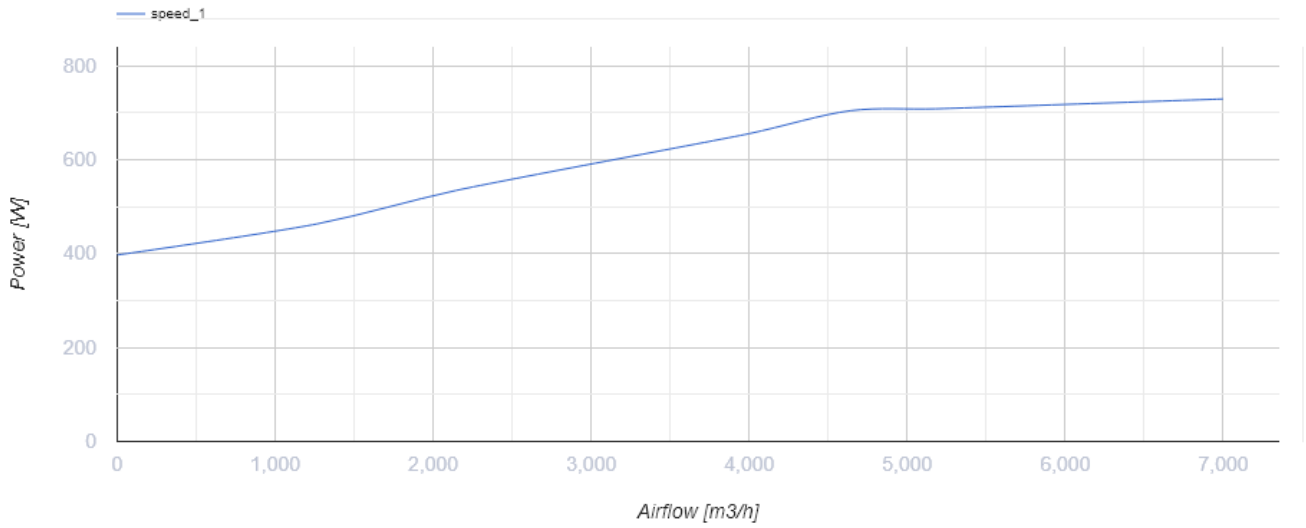
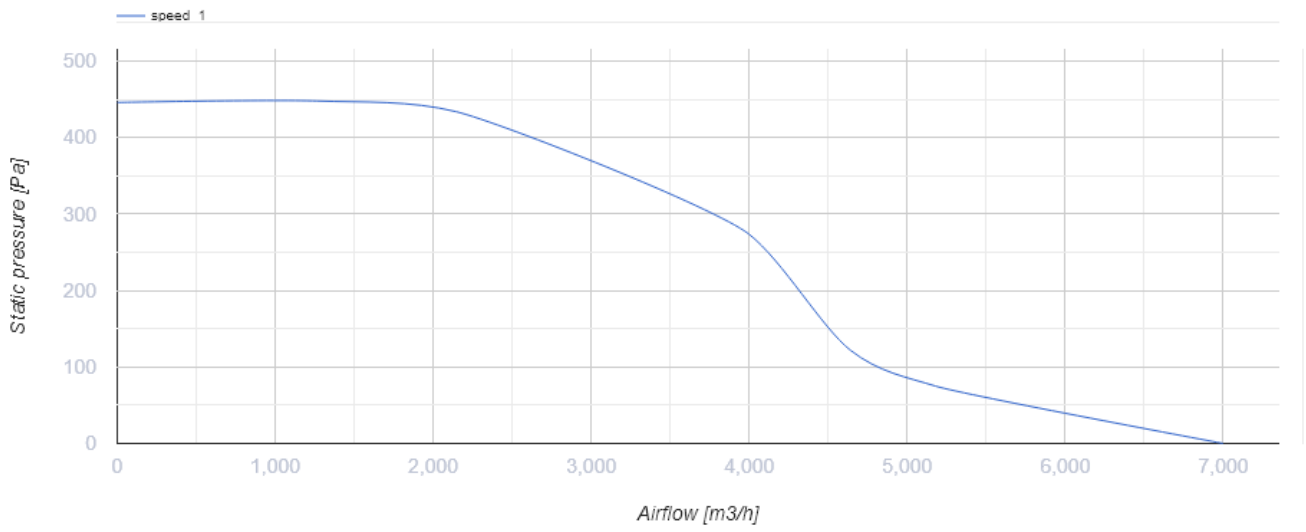

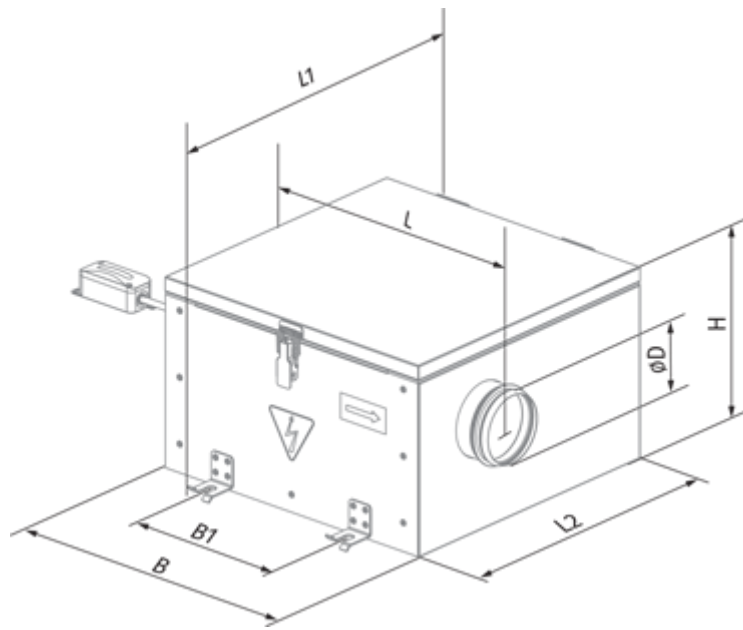

Dimensions

Ø D	B	B1	H	L	L1	L2
499	1203	993	744	1300	1263	1182



Accessories

Other accessories

Name	Photo	Description
CDTE E10.0 TP		Speed controllers
CDTE E5.0 TP		Speed controllers
CDTE E3.0 TP		Speed controllers