

Iso-RB 400

Sound-insulated inline centrifugal fans

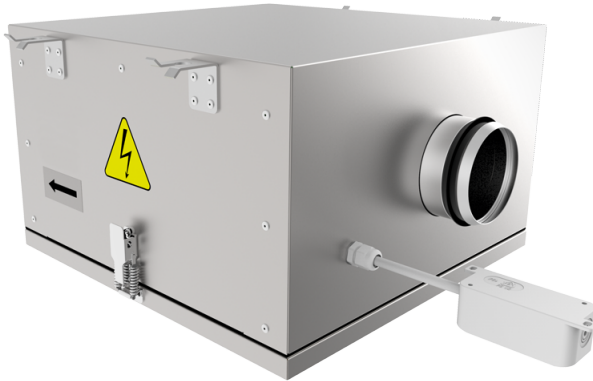

- Maximum airflow: 3800
- Sound pressure level LpA at 3 m: 49
- Sound insulation
- Motor type: AC
- Impeller type: Centrifugal backward curved blades
- Casing material: Aluzinc
- Installation in any position

	Unit of measurement	Iso-RB 400	
Connected air duct size	mm	400	
Speed	-	1	
Phases	-	1	
Minimum supply voltage	V	230	
Maximum supply voltage	V	230	
Power supply frequency	Hz	50	60
Rated power	W	427	
Unit current	A	1.87	
Maximum airflow	m ³ /h	3800	
rotation speed at 50hz	-	1451	
Sound pressure level LpA at 3 m	dB(A)	49	
Weight	kg	78.5	
Transported air temperature (max)	°C	55	
Transported air temperature (min)	°C	-25	
Ingress protection rating	-	IPX4	
Ingress protection rating of the drive	-	IP54	

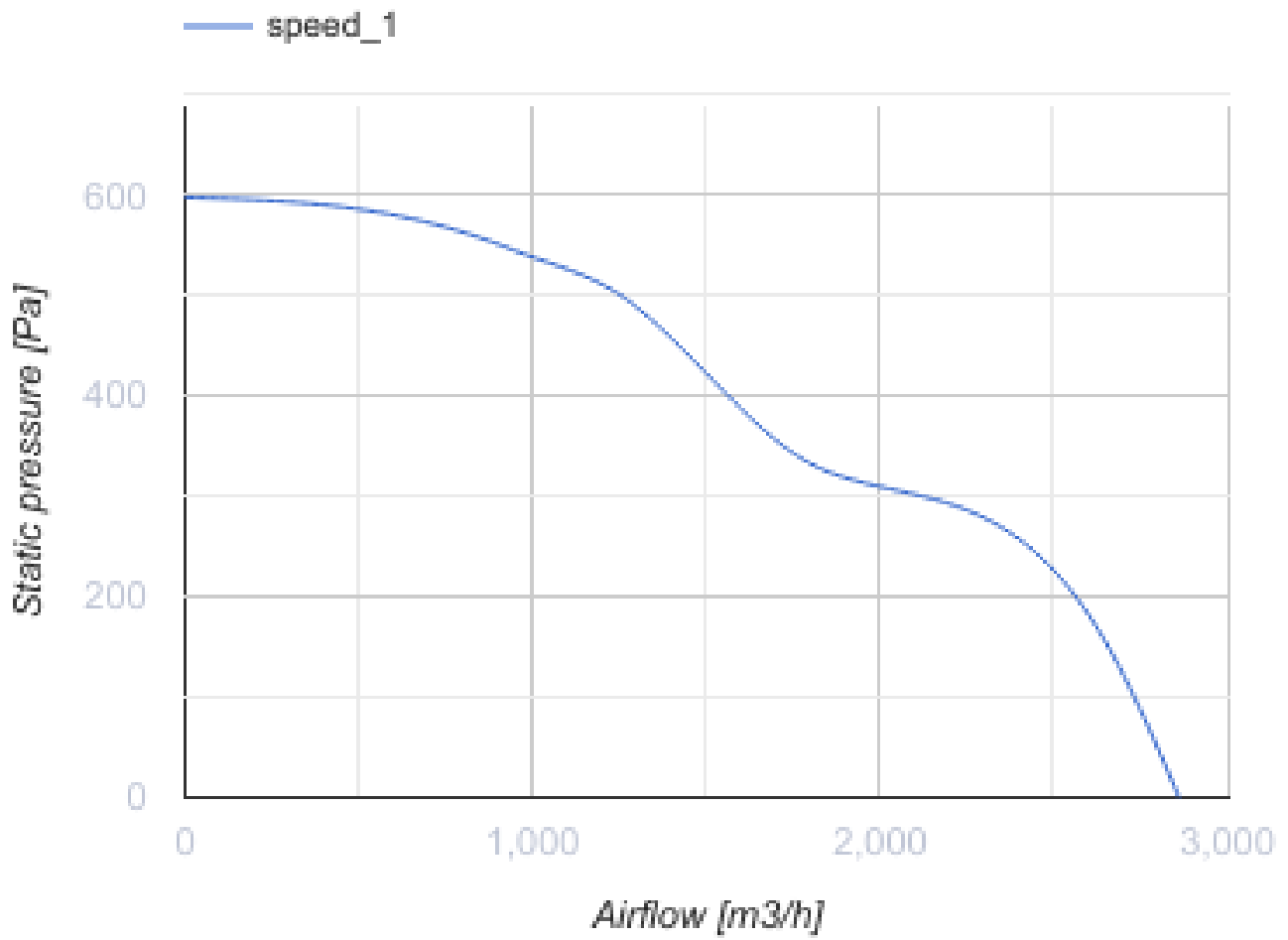

Dimensions

Ø D	B	B1	H	L	L1	L2
399	927	737	578	1024	957	876

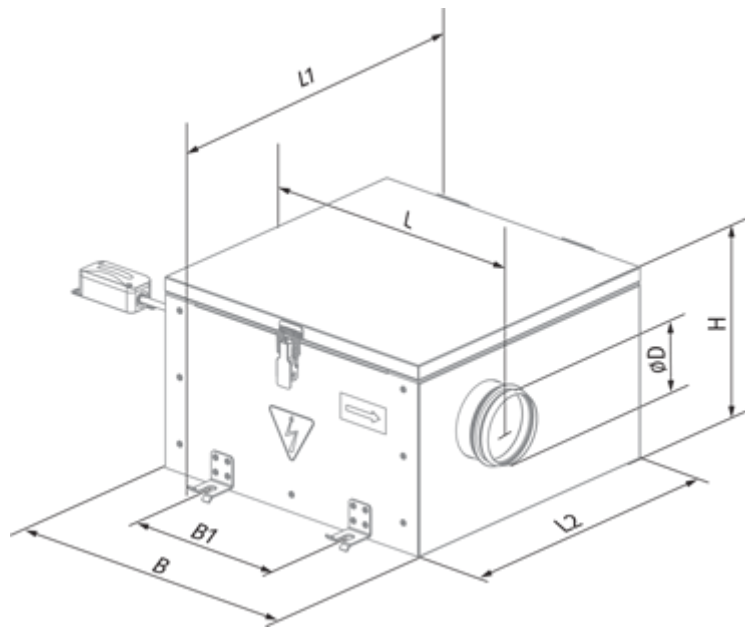



Ecodesign

Trademark	Blauberg
Model	Iso-RB 400
Type of ventilation unit	Unidirectional
Type of drive installed	External MSD or VSD
Type of heat recovery system	None
Nominal flow rate (m ³ /s)	0.503
Nominal external pressure (Pa)	436
Maximum external leakage rates (%)	2.7
Static efficiency (%)	56.3
Declared typology	NRVU UVU
Sound power level (dB(A))	68
Effective electric power input (kW)	0.398

Accessories

Thyristor speed controllers

Name	Photo	Description
CDTE E5.0 TP		Speed controllers
CDTE E3.0 TP		Speed controllers
CDTE E10.0 TP		Speed controllers

For round ducts

Name	Photo	Description
VKA 400		Air dampers for round ducts

For round ducts

Name	Photo	Description
------	-------	-------------

SD 400/1200		Silencers for round ducts
SD 400/900		Silencers for round ducts