

Iso-RB 250

Centrifugal inline fans with backward curved blades in cases with improved sound insulation properties

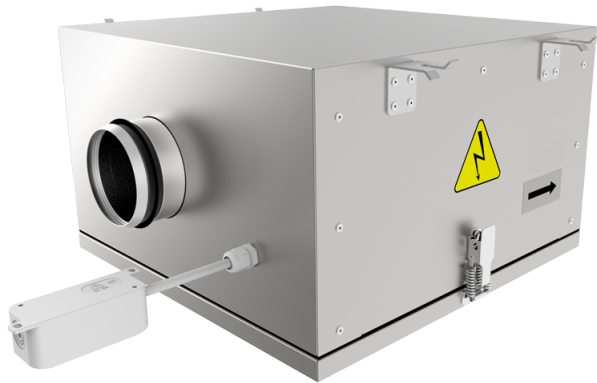

- Sound pressure level LpA at 3 m: 45
- Sound-insulated casing
- Impeller type: Centrifugal impeller with backward curved blades
- Casing material: Galvanized steel
- Installation in any position

	Unit of measurement	Iso-RB 250
Connected air duct size	mm	250
Phases	-	1
Minimum supply voltage	V	230
Maximum supply voltage	V	230
Power supply frequency	Hz	50
Rated power	W	320
Unit current	A	1.4
Maximum airflow	m ³ /h	1515
Rotation speed at 50hz	-	2615
Sound pressure level LpA at 3 m	dB(A)	45
Weight	kg	33
Transported air temperature (max)	°C	55
Transported air temperature (min)	°C	-25
Ingress protection rating	-	IPX4
Ingress protection rating of the drive	-	IP44
Impeller material	-	Galvanized steel
Article	-	8051470

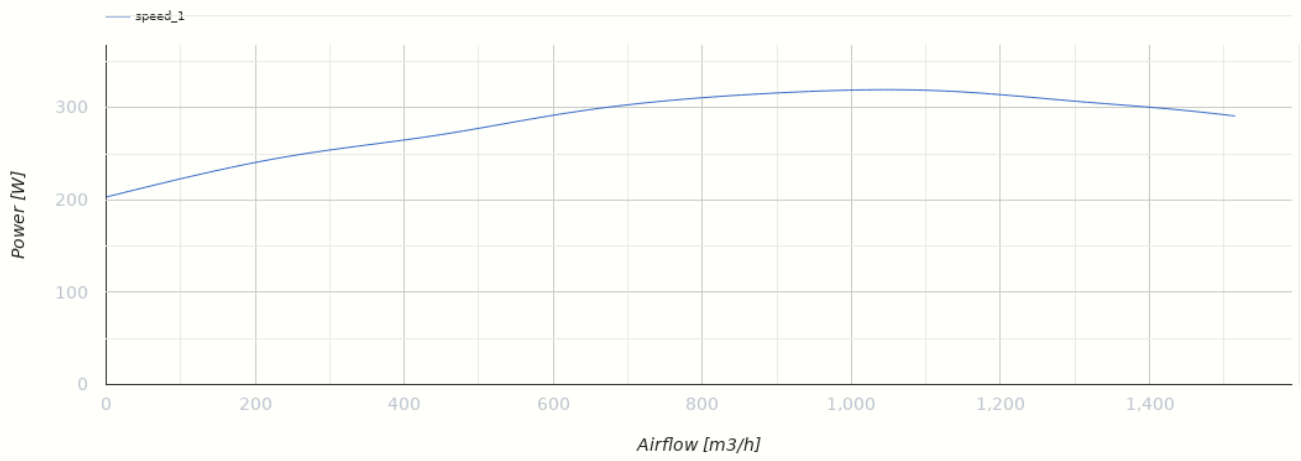
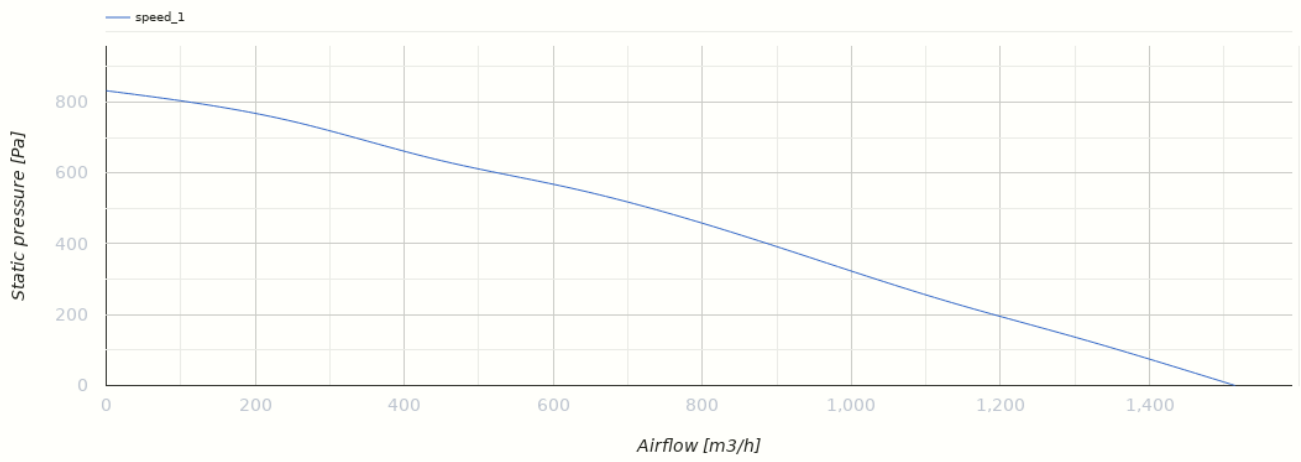

Dimensions

Ø D	B	B1	H	L	L1	L2
248	677	537	429	774	759	666

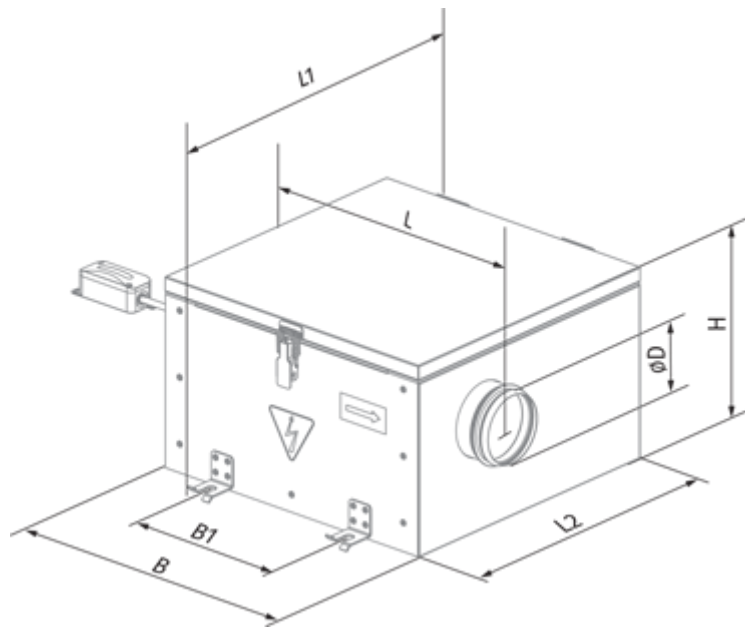



Ecodesign



Trademark	Blauberg
Model	Iso-RB 250
Type of ventilation unit	Unidirectional
Type of drive installed	External MSD or VSD
Type of heat recovery system	None
Nominal external pressure (Pa)	463
Maximum external leakage rates (%)	2.7
Static efficiency (%)	36.6
Declared typology	NRVU UVU
Effective electric power input (kW)	0.324
Sound power level (dB(A))	65



Accessories

Other accessories



Name	Photo	Description
SD 250/600		Silencers for round ducts
SD 250/900		Silencers for round ducts
SD 250/1200		Silencers for round ducts

Other accessories









Name	Photo	Description
KFBK 250		Filter boxes for round ducts
KFBT 250 G4		Filter boxes with pocket filters for round ducts

KFBT 250 F5		Filter boxes with pocket filters for round ducts
KFBT 250 F7		Filter boxes with pocket filters for round ducts

Other accessories

Name	Photo	Description
VRV 250		Backdraft dampers with spring for round ducts
VKA 250		Air dampers for round ducts

Other accessories

Name	Photo	Description
WKH 250-2		Duct water heaters for round ducts
WKH 250-4		Duct water heaters for round ducts
EKH 250-1.2		Duct electrical heaters for round ducts
EKH 250-2.0		Duct electrical heaters for round ducts
EKH 250-2.4		Duct electrical heaters for round ducts
EKH 250-3.0		Duct electrical heaters for round ducts
EKH 250-3.6		Duct electrical heaters for round ducts
EKH 250-6.0		Duct electrical heaters for round ducts

[EKH 250-9.0](#)



Duct electrical heaters for round ducts