

Iso-RB 125

Centrifugal inline fans with backward curved blades in cases with improved sound insulation properties

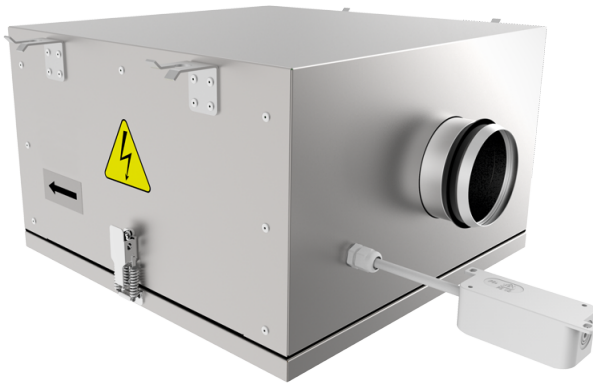

- Maximum airflow: 330
- Sound pressure level LpA at 3 m: 35
- Sound insulation
- Motor type: AC
- Impeller type: Centrifugal backward curved blades
- Casing material: Aluzinc
- Installation in any position

	Unit of measurement	Iso-RB 125
Connected air duct size	mm	125
Speed	-	1
Phases	-	1
Minimum supply voltage	V	230
Maximum supply voltage	V	230
Power supply frequency	Hz	50
Rated power	W	61
Unit current	A	0.28
Maximum airflow	m ³ /h	330
rotation speed at 50hz	-	2560
Sound pressure level LpA at 3 m	dB(A)	35
Weight	kg	13
Transported air temperature (max)	°C	55
Transported air temperature (min)	°C	-25
Ingress protection rating	-	IPX4
Ingress protection rating of the drive	-	IP44

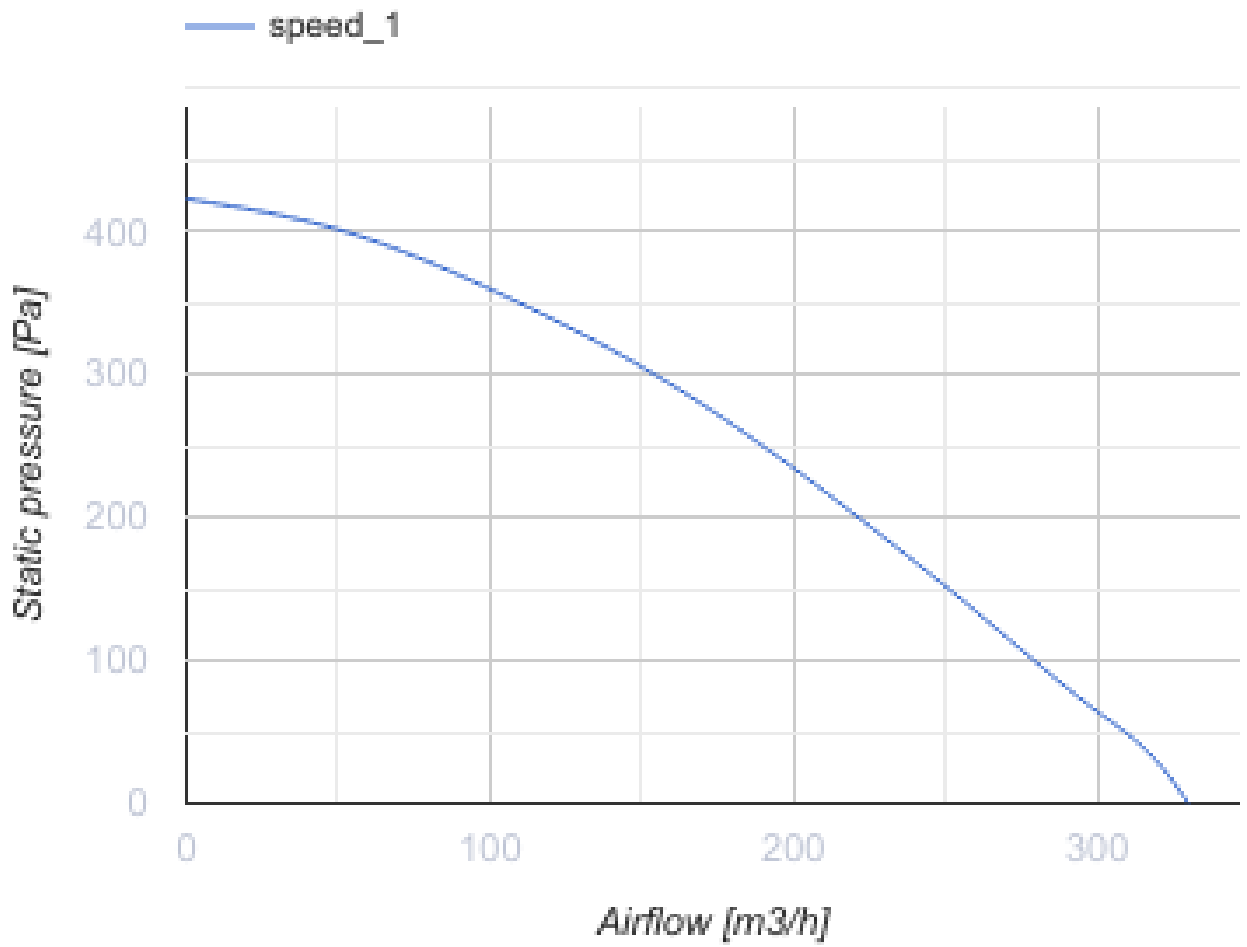

Dimensions

Ø D	B	B1	H	L	L1	L2
124	420	228	258	517	507	414

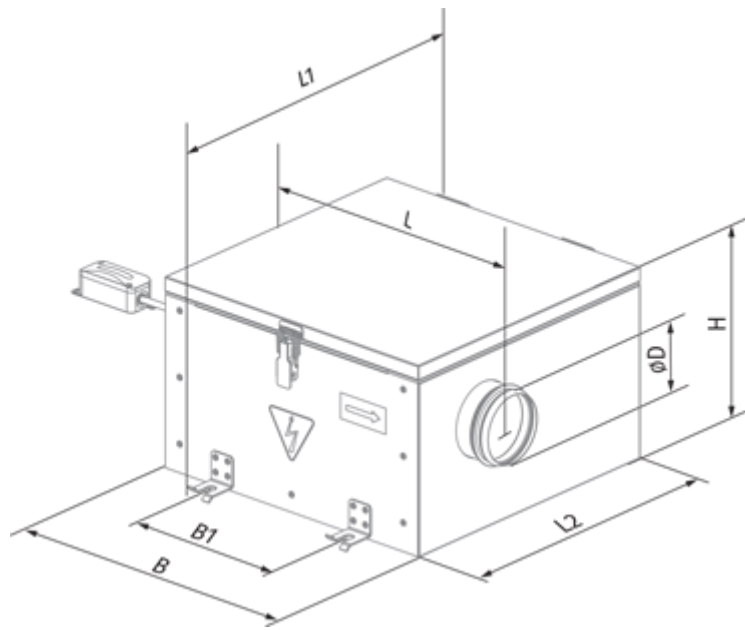

Ecodesign

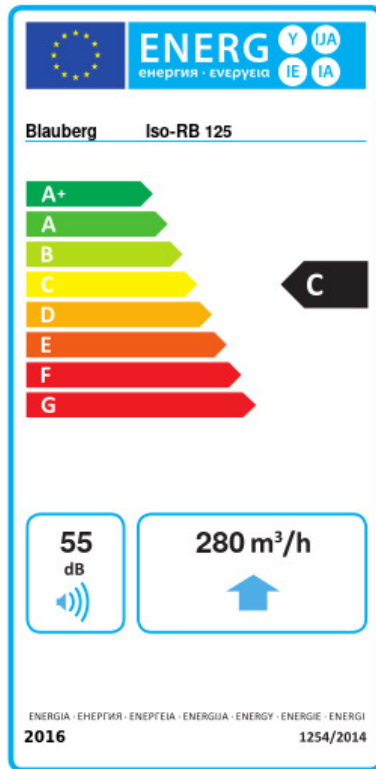



Trademark	Blaubeerg					
Model	Iso-RB 125					
Specific energy consumption (SEC) (kWh/(m²/a))	Cold		Average		Warm	
	-51.4	A+	-24.3	C	-8.8	F
Type of ventilation unit	Unidirectional					
Type of drive installed	Variable speed					
Type of heat recovery system	None					
Maximum flow rate (m³/h)	280					
Electric power input (W)	60.7					
Reference flow rate (m³/s)	0.054					
Reference pressure difference (Pa)	50					
Specific power input (SPI) (W/(m³/h))	0.301					
Control typology	Local demand control					
Maximum external leakage rates (%)	2.7					
Declared typology	RVU UVU					
Sound power level (dB(A))	55					
The annual electricity consumption (AEC) (kWh/a)	Cold		Average		Warm	
	159		159		159	
The annual heating saved (AHS) (kWh/a)	Cold		Average		Warm	
	5536		2830		1280	





Accessories

Other accessories



Name	Photo	Description
EKH 125-0.8		Duct electrical heaters for round ducts
EKH 125-0.6		Duct electrical heaters for round ducts
WKH 125-4		Duct water heaters for round ducts

WKH 125-2		Duct water heaters for round ducts
EKH 125-2.4		Duct electrical heaters for round ducts
EKH 125-1.6		Duct electrical heaters for round ducts
EKH 125-1.2		Duct electrical heaters for round ducts

Other accessories

Name	Photo	Description
KFBT 125 F7		Filter boxes with pocket filters for round ducts
KFBT 125 F5		Filter boxes with pocket filters for round ducts
KFBT 125 G4		Filter boxes with pocket filters for round ducts
KFBK 125		Filter boxes for round ducts

Other accessories



Name	Photo	Description
SD 125/1200		Silencers for round ducts
SD 125/900		Silencers for round ducts
SD 125/600		Silencers for round ducts

Other accessories

Name	Photo	Description
------	-------	-------------

CDTE E3.0 TP		Speed controllers
------------------------------	---	-------------------

Other accessories

Name	Photo	Description
VKA 125		Air dampers for round ducts
VRV 125		Backdraft dampers with spring for round ducts