

# Iso-Primo EC 400 G1

Mixed-flow inline fans in sound-insulated casings with EC-motors



- Maximum airflow: 5415
- Sound pressure level LpA at 3 m: 49
- Sound insulation
- Motor type: EC
- Control: Speed controller
- Impeller type: Mixed-flow
- Casing material: Galvanized steel
- Installation in any position
- Cable with mains plug
- Temperature sensor: Remote

	Unit of measurement	Iso-Primo EC 400 G1
Connected air duct size	mm	400
Speed	-	1
Phases	-	1
Minimum supply voltage	V	230
Maximum supply voltage	V	230
Power supply frequency	Hz	50/60
Rated power	W	726
Unit current	A	4.8
Maximum airflow	m <sup>3</sup> /h	5415
rotation speed at 50hz	-	2580
Sound pressure level LpA at 3 m	dB(A)	49
Weight	kg	22.8
Transported air temperature (max)	°C	55
Transported air temperature (min)	°C	-25
Ambient air temperature min	°C	1
Ambient air temperature max	°C	40
Ingress protection rating	-	IPX4
Ingress protection rating of the drive	-	IP44

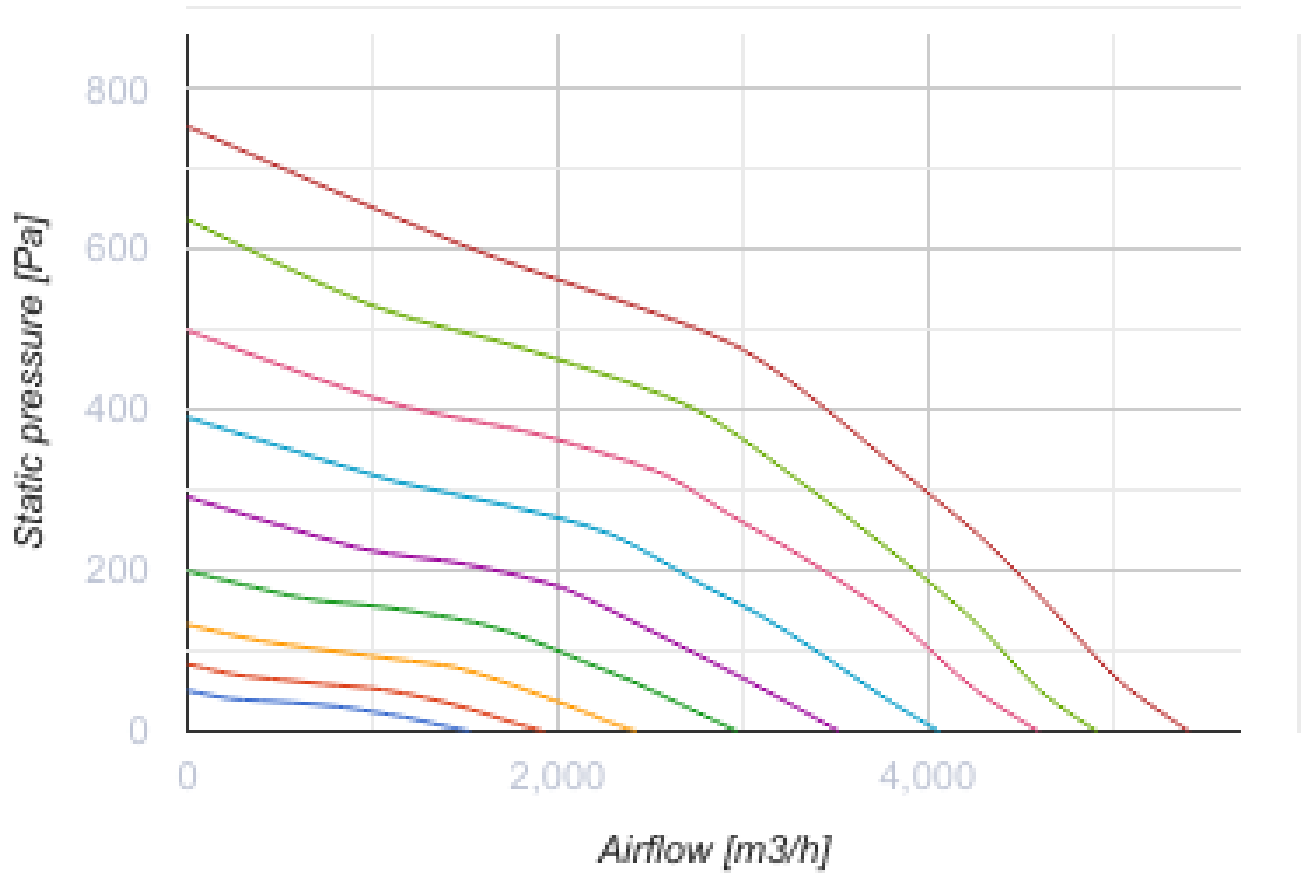

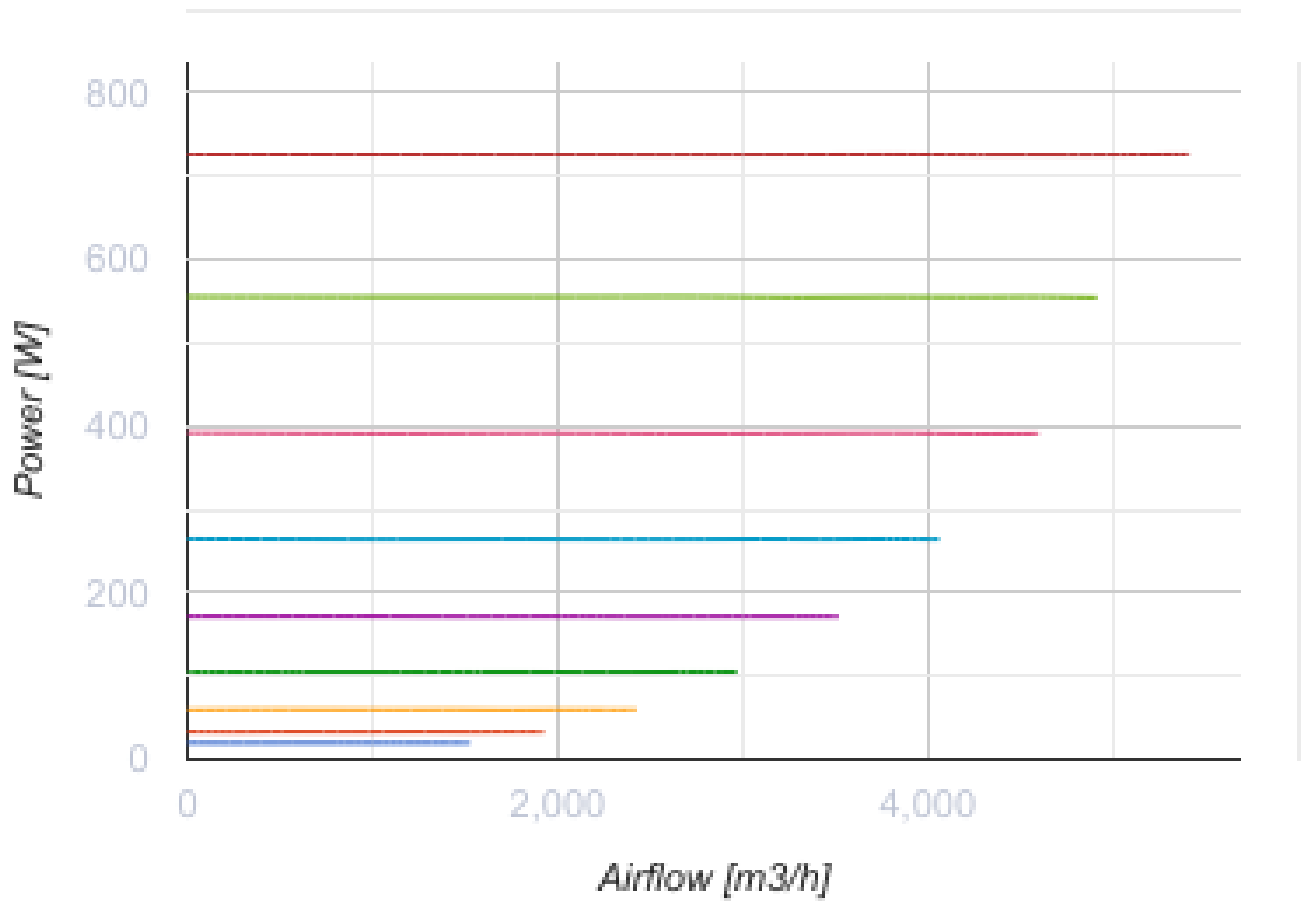

### Dimensions

Ø D	Ø D1	H	L	L1
399	460	517	648	785

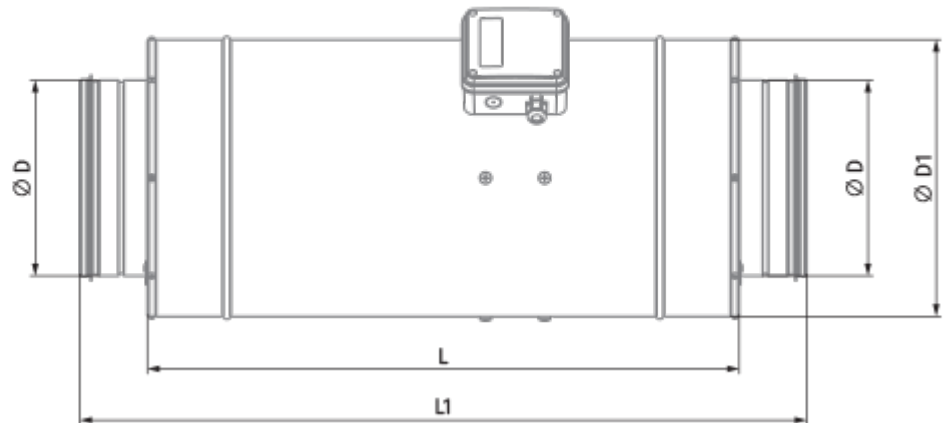
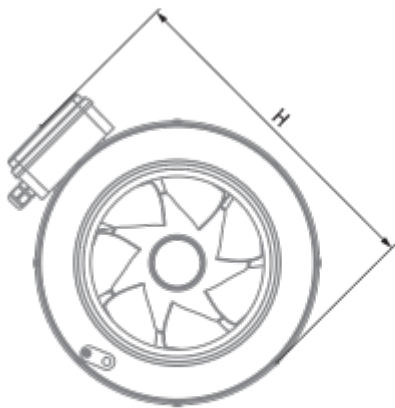

## Accessories



### Other accessories

Name	Photo	Description
<a href="#">CDT E/0-10</a>		Speed control for EC motors

### Other accessories

Name	Photo	Description
<a href="#">VKA 400</a>		Air dampers for round ducts

### Other accessories

Name	Photo	Description
<a href="#">SD 400/1200</a>		Silencers for round ducts
<a href="#">SD 400/900</a>		Silencers for round ducts