

# Iso-Primo EC 315 T



Sound-insulated inline mixed-flow fans with EC motor

- Maximum airflow: 3090
- Sound pressure level LpA at 3 m: 47
- Sound insulation
- Motor type: EC
- Impeller type: Mixed-flow
- Casing material: Galvanized steel
- Installation in any position
- Timer: Turn off timer

	Unit of measurement	Iso-Primo EC 315 T
Connected air duct size	mm	315
Speed	-	1
Phases	-	1
Minimum supply voltage	V	230
Maximum supply voltage	V	230
Power supply frequency	Hz	50/60
Rated power	W	353
Unit current	A	1.56
Maximum airflow	m <sup>3</sup> /h	3090
rotation speed at 50hz	-	2470
Sound pressure level LpA at 3 m	dB(A)	47
Weight	kg	20.7
Transported air temperature (max)	°C	55
Transported air temperature (min)	°C	-25
Ambient air temperature min	°C	1
Ambient air temperature max	°C	40
Ingress protection rating	-	IPX4
Ingress protection rating of the drive	-	IP44



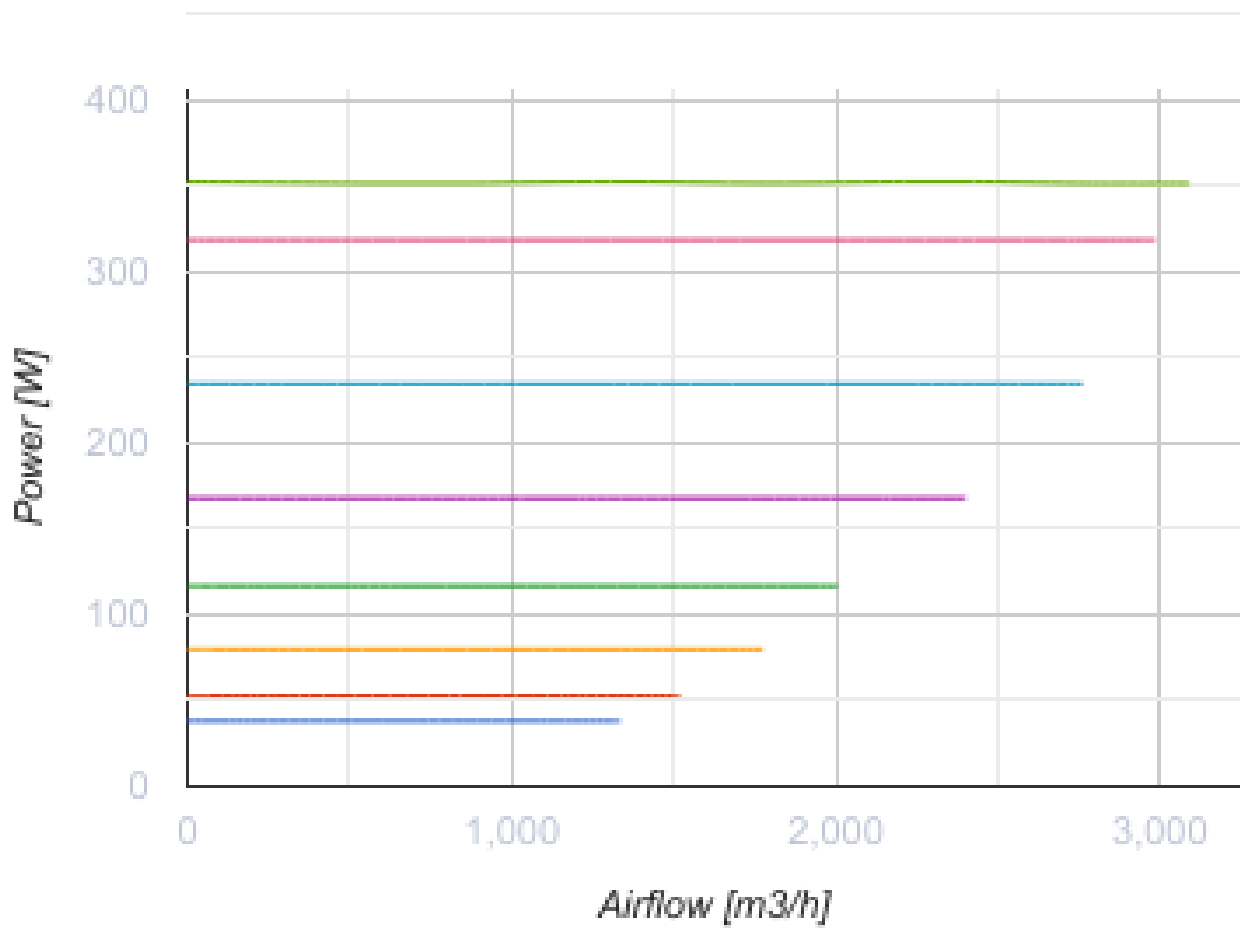

### Dimensions

Ø D	Ø D1	H	L	L1
314	412	468	601	739

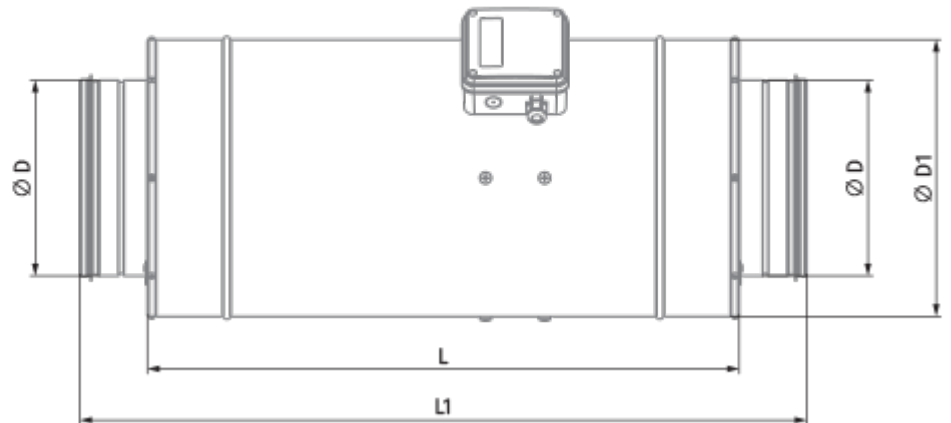
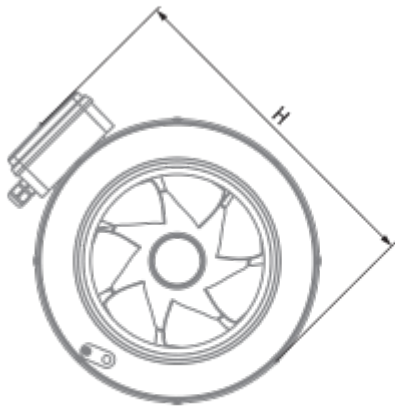

## Accessories



### EC motors regulators

Name	Photo	Description
<a href="#">CDT E/0-10</a>		Speed control for EC motors

### For round ducts







Name	Photo	Description
<a href="#">VKA 315</a>		Air dampers for round ducts
<a href="#">VRV 315</a>		Backdraft dampers with spring for round ducts

### Water heaters





Name	Photo	Description
<a href="#">WKH 315-4</a>		Duct water heaters for round ducts
<a href="#">WKH 315-2</a>		Duct water heaters for round ducts

### Electrical heaters



Name	Photo	Description
------	-------	-------------

<a href="#">EKH 315-9.0</a>		Duct electrical heaters for round ducts
<a href="#">EKH 315-6.0</a>		Duct electrical heaters for round ducts
<a href="#">EKH 315-3.6</a>		Duct electrical heaters for round ducts
<a href="#">EKH 315-2.4</a>		Duct electrical heaters for round ducts
<a href="#">EKH 315-2.0</a>		Duct electrical heaters for round ducts
<a href="#">EKH 315-1.2</a>		Duct electrical heaters for round ducts

#### For round ducts

Name	Photo	Description
<a href="#">KFBT 315 F7</a>		Filter boxes with pocket filters for round ducts
<a href="#">KFBT 315 F5</a>		Filter boxes with pocket filters for round ducts
<a href="#">KFBT 315 G4</a>		Filter boxes with pocket filters for round ducts
<a href="#">KFBK 315</a>		Filter boxes for round ducts

#### For round ducts

Name	Photo	Description
<a href="#">SD 315/1200</a>		Silencers for round ducts
<a href="#">SD 315/900</a>		Silencers for round ducts

[SD 315/600](#)



Silencers for round ducts