

Iso-Primo EC 315 G1

Sound-insulated inline mixed-flow fans with EC motor



- Maximum airflow: 3090
- Sound pressure level LpA at 3 m: 47
- Sound insulation
- Motor type: EC
- Control: Speed controller
- Impeller type: Mixed-flow
- Casing material: Galvanized steel
- Installation in any position
- Cable with mains plug
- Temperature sensor: Remote

	Unit of measurement	Iso-Primo EC 315 G1
Connected air duct size	mm	315
Speed	-	1
Phases	-	1
Minimum supply voltage	V	230
Maximum supply voltage	V	230
Power supply frequency	Hz	50/60
Rated power	W	353
Unit current	A	1.56
Maximum airflow	m ³ /h	3090
rotation speed at 50hz	-	2470
Sound pressure level LpA at 3 m	dB(A)	47
Weight	kg	20.7
Transported air temperature (max)	°C	55
Transported air temperature (min)	°C	-25
Ambient air temperature min	°C	1
Ambient air temperature max	°C	40
Ingress protection rating	-	IPX4
Ingress protection rating of the drive	-	IP44

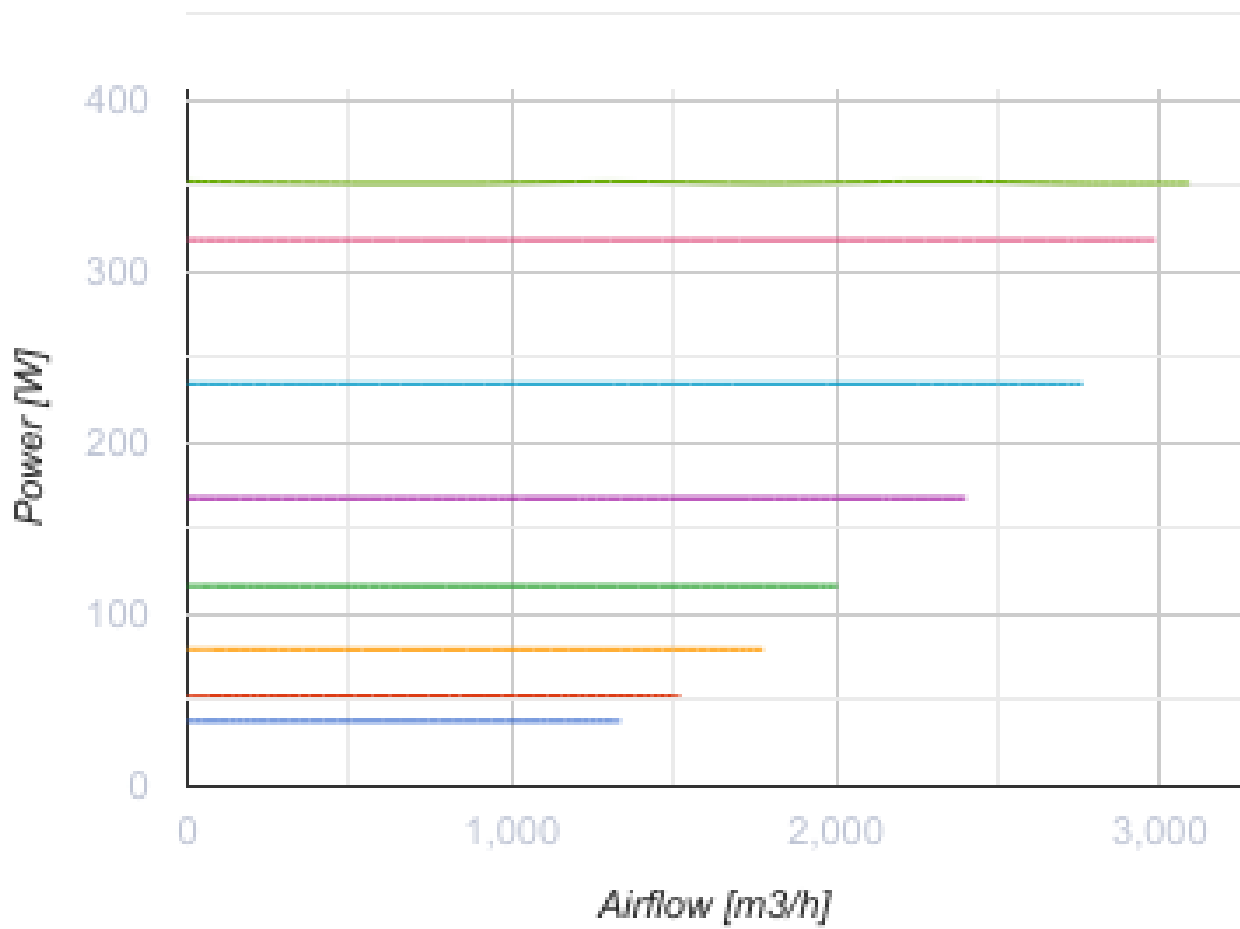





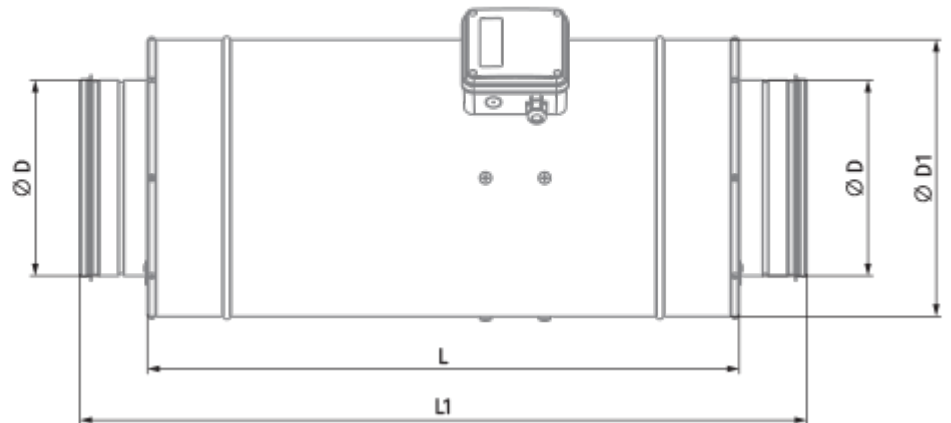
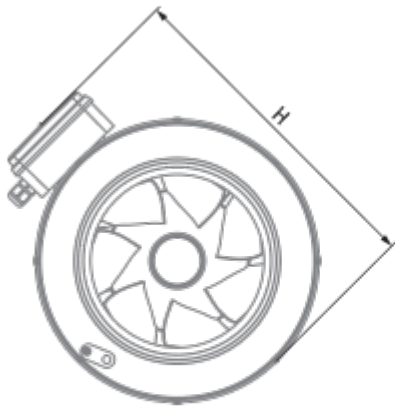

Dimensions

Ø D	Ø D1	H	L	L1
314	412	468	601	739







Accessories

Electrical heaters



Name	Photo	Description
EKH 315-2.4		Duct electrical heaters for round ducts
EKH 315-2.0		Duct electrical heaters for round ducts
EKH 315-1.2		Duct electrical heaters for round ducts
EKH 315-3.6		Duct electrical heaters for round ducts
EKH 315-6.0		Duct electrical heaters for round ducts
EKH 315-9.0		Duct electrical heaters for round ducts

For round ducts



Name	Photo	Description
KFBT 315 F7		Filter boxes with pocket filters for round ducts

KFBT 315 F5		Filter boxes with pocket filters for round ducts
KFBT 315 G4		Filter boxes with pocket filters for round ducts
KFBK 315		Filter boxes for round ducts

For round ducts

Name	Photo	Description
SD 315/1200		Silencers for round ducts
SD 315/900		Silencers for round ducts
SD 315/600		Silencers for round ducts

Water heaters

Name	Photo	Description
WKH 315-2		Duct water heaters for round ducts
WKH 315-4		Duct water heaters for round ducts

For round ducts

Name	Photo	Description
VRV 315		Backdraft dampers with spring for round ducts
VKA 315		Air dampers for round ducts

EC motors regulators

Name	Photo	Description
------	-------	-------------

[CDT E/0-10](#)



Speed control for EC motors