

Iso-Primo EC 250

Sound-insulated inline mixed-flow fans with EC motor



- Maximum airflow: 1750
- Sound pressure level LpA at 3 m: 48
- Sound insulation
- Motor type: EC
- Impeller type: Mixed
- Casing material: Galvanized steel
- Installation in any position

	Unit of measurement	Iso-Primo EC 250
Connected air duct size	mm	250
Speed	-	1
Phases	-	1
Minimum supply voltage	V	230
Maximum supply voltage	V	230
Power supply frequency	Hz	50/60
Rated power	W	168
Unit current	A	1.34
Maximum airflow	m ³ /h	1750
rotation speed at 50hz	-	3282
Sound pressure level LpA at 3 m	dB(A)	48
Weight	kg	9.8
Transported air temperature (max)	°C	55
Transported air temperature (min)	°C	-25
Ambient air temperature min	°C	1
Ambient air temperature max	°C	40
Ingress protection rating	-	IPX4
Ingress protection rating of the drive	-	IP44

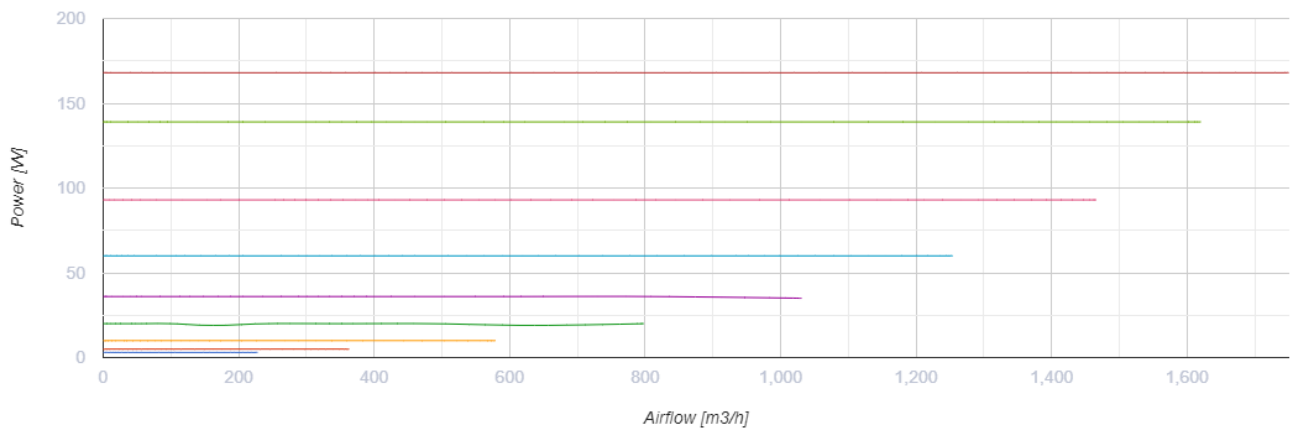
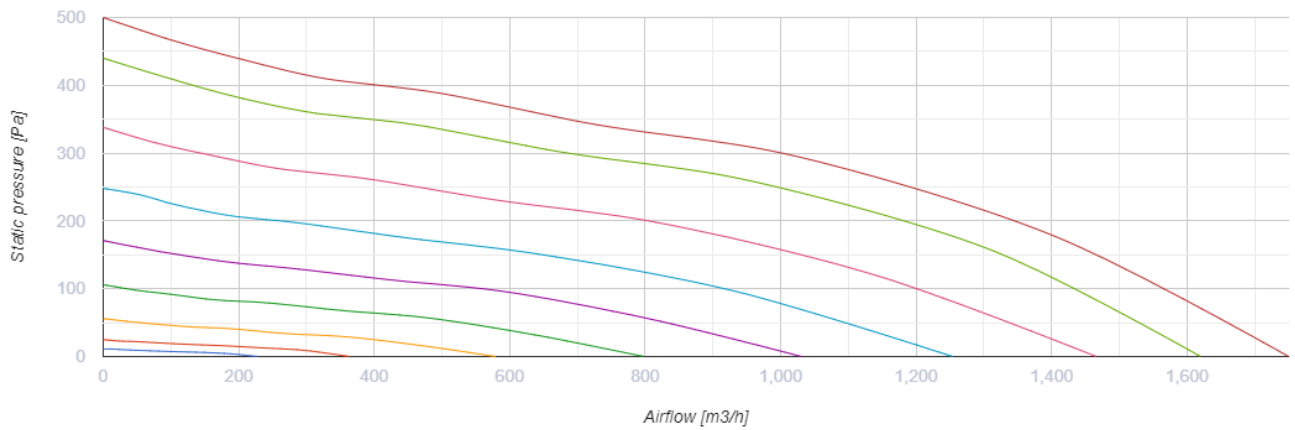

Dimensions

Ø D	Ø D1	H	L	L1
249	337	389	601	739

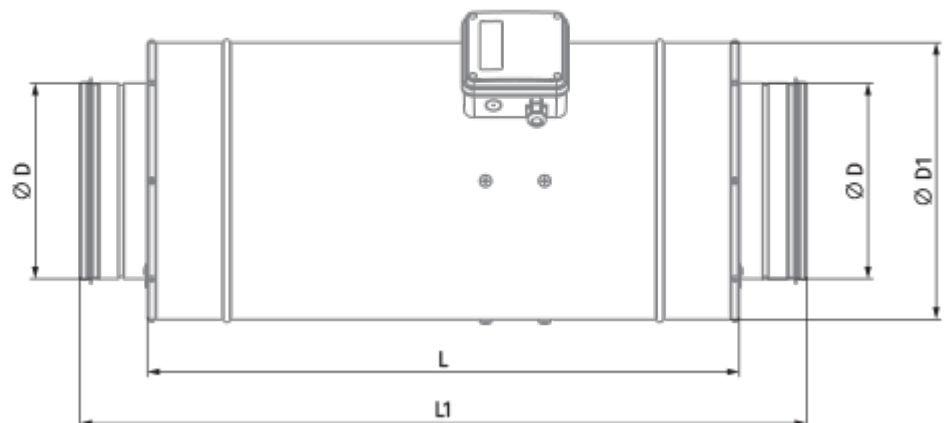
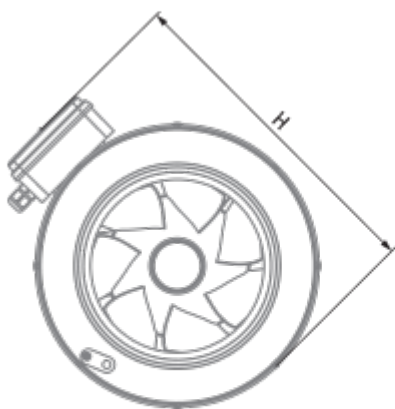







Ecodesign





Trademark	Blauberg
Model	Iso-Primo EC 250
Type of ventilation unit	Unidirectional
Type of drive installed	Integrated VSD
Type of heat recovery system	None
Nominal flow rate (m ³ /s)	0.264
Nominal external pressure (Pa)	260
Maximum external leakage rates (%)	2.7
Static efficiency (%)	50.4
Effective electric power input (kW)	0.139
Sound power level (dB(A))	60
Declared typology	NRVU UVU

Accessories









Other accessories

Name	Photo	Description
MLCD E2		Room temperature regulator
CDP-2/5		Multi-speed switch
CDP-3/5		Multi-speed switch
CDT E0.5		Thyristor speed controller
CDT E1.8		Thyristor speed controller
CDT E/0-10		Speed control for EC motors

Other accessories

Name	Photo	Description
TE / TI 1.5		Timers
IRSE / IRSI 1.5		Sensors
LSE / LSI 1.5		Sensors
HSE / HSI 1.5		Sensors

Other accessories



Name	Photo	Description
WKH 250-4		Duct water heaters for round ducts
WKH 250-2		Duct water heaters for round ducts
EKH 250-9.0		Duct electrical heaters for round ducts
EKH 250-6.0		Duct electrical heaters for round ducts
EKH 250-3.6		Duct electrical heaters for round ducts
EKH 250-3.0		Duct electrical heaters for round ducts
EKH 250-2.4		Duct electrical heaters for round ducts
EKH 250-2.0		Duct electrical heaters for round ducts

EKH 250-1.2		Duct electrical heaters for round ducts
-----------------------------	---	---

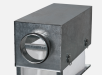
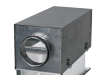

Other accessories

Name	Photo	Description
VKA 250		Air dampers for round ducts
VRV 250		Backdraft dampers with spring for round ducts

Other accessories

Name	Photo	Description
KFBT 250 F7		Filter boxes with pocket filters for round ducts
KFBT 250 F5		Filter boxes with pocket filters for round ducts
KFBT 250 G4		Filter boxes with pocket filters for round ducts
KFBK 250		Filter boxes for round ducts

Other accessories

Name	Photo	Description
SD 250/1200		Silencers for round ducts
SD 250/900		Silencers for round ducts
SD 250/600		Silencers for round ducts