

# Iso-Primo EC 200 G1

Mixed-flow inline fans in sound-insulated casings with EC-motors



- Maximum airflow: 1210
- Sound pressure level LpA at 3 m: 47
- Sound insulation
- Motor type: EC
- Control: Speed controller
- Impeller type: Mixed-flow
- Casing material: Galvanized steel
- Installation in any position
- Cable with mains plug
- Temperature sensor: Remote

	Unit of measurement	Iso-Primo EC 200 G1
Connected air duct size	mm	200
Speed	-	1
Phases	-	1
Minimum supply voltage	V	230
Maximum supply voltage	V	230
Power supply frequency	Hz	50/60
Rated power	W	121
Unit current	A	0.96
Maximum airflow	m <sup>3</sup> /h	1210
rotation speed at 50hz	-	3100
Sound pressure level LpA at 3 m	dB(A)	47
Weight	kg	8.2
Transported air temperature (max)	°C	55
Transported air temperature (min)	°C	-25
Ambient air temperature min	°C	1
Ambient air temperature max	°C	40
Ingress protection rating	-	IPX4
Ingress protection rating of the drive	-	IP44

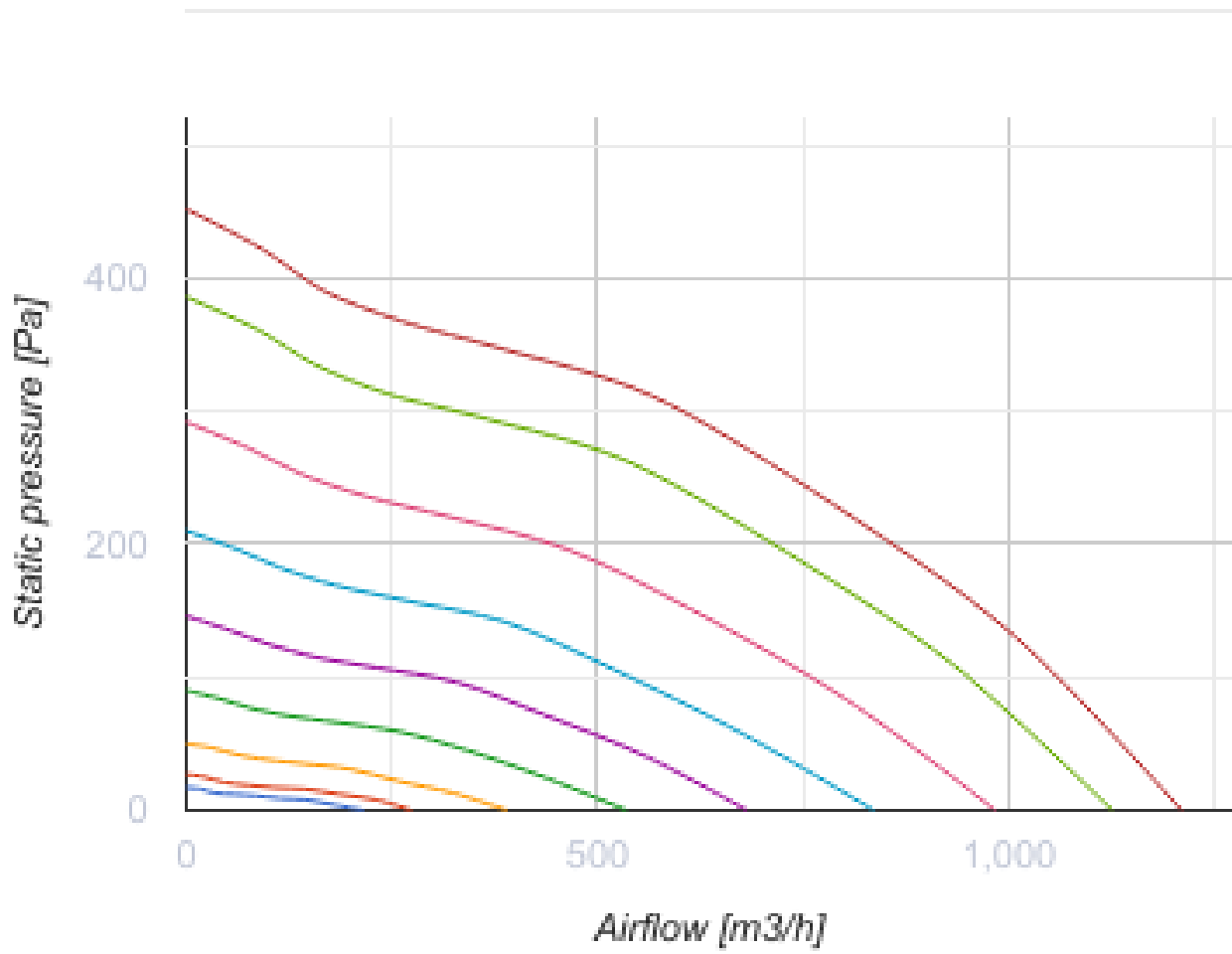

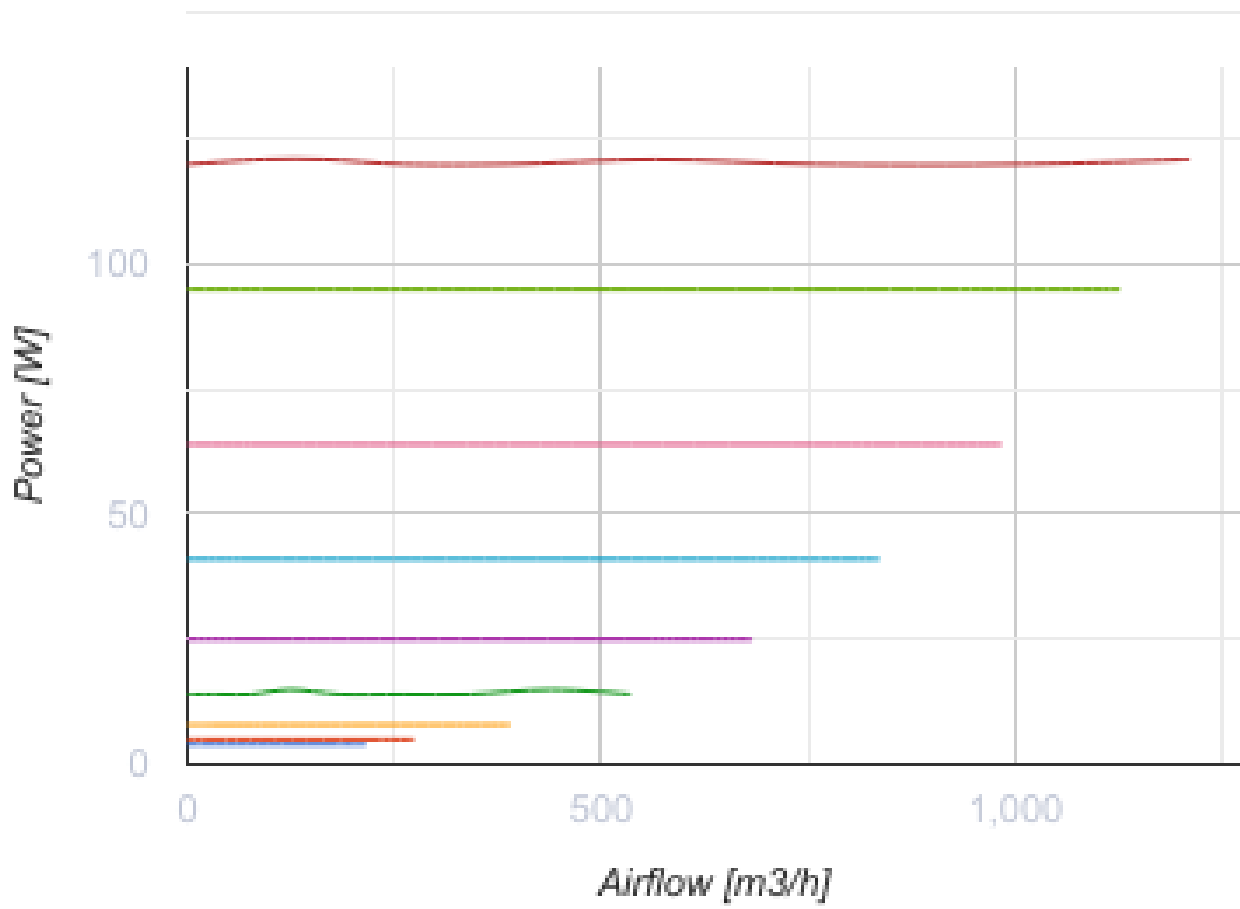

## Dimensions

Ø D	Ø D1	H	L	L1
199	281	339	601	739

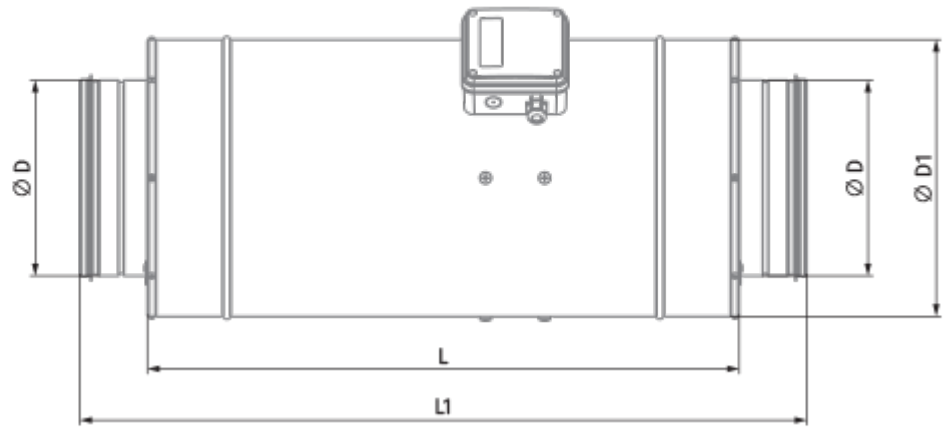
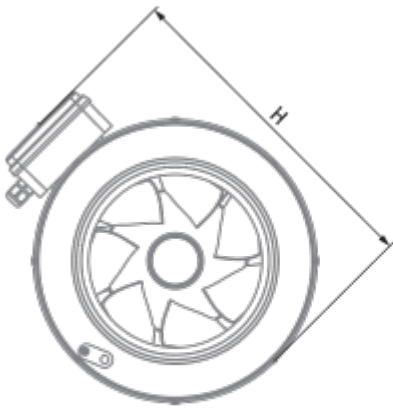

## Ecodesign







Trademark	Blauberg
Model	Iso-Primo EC 200 G1



## Accessories

### Other accessories





Name	Photo	Description
<a href="#">VKA 200</a>		Air dampers for round ducts
<a href="#">VRV 200</a>		Backdraft dampers with spring for round ducts

### Other accessories



Name	Photo	Description
<a href="#">WKH 200-4</a>		Duct water heaters for round ducts
<a href="#">EKH 200-6.0</a>		Duct electrical heaters for round ducts
<a href="#">EKH 200-3.6</a>		Duct electrical heaters for round ducts
<a href="#">EKH 200-2.4</a>		Duct electrical heaters for round ducts
<a href="#">EKH 200-2.0</a>		Duct electrical heaters for round ducts
<a href="#">EKH 200-1.2</a>		Duct electrical heaters for round ducts
<a href="#">EKH 200-1.7</a>		Duct electrical heaters for round ducts

<a href="#">EKH 200-3.4</a>		Duct electrical heaters for round ducts
<a href="#">EKH 200-5.1</a>		Duct electrical heaters for round ducts
<a href="#">WKH 200-2</a>		Duct water heaters for round ducts

### Other accessories

Name	Photo	Description
<a href="#">KFBT 200 F5</a>		Filter boxes with pocket filters for round ducts
<a href="#">KFBK 200</a>		Filter boxes for round ducts
<a href="#">KFBT 200 G4</a>		Filter boxes with pocket filters for round ducts
<a href="#">KFBT 200 F7</a>		Filter boxes with pocket filters for round ducts

### Other accessories

Name	Photo	Description
<a href="#">SD 200/1200</a>		Silencers for round ducts
<a href="#">SD 200/600</a>		Silencers for round ducts
<a href="#">SD 200/900</a>		Silencers for round ducts

### Other accessories

Name	Photo	Description
<a href="#">CDT E/0-10</a>		Speed control for EC motors