

Iso-Primo 400 W

Sound-insulated inline mixed-flow fans



- Maximum airflow: 3185
- Sound pressure level LpA at 3 m: 37
- Sound insulation
- Motor type: AC
- Impeller type: Mixed-flow
- Casing material: Galvanized steel
- Installation in any position
- Cable with mains plug

	Unit of measurement	Iso-Primo 400 W		
Connected air duct size	mm	400		
Speed	-	3		
Phases	-	1		
Minimum supply voltage	V	230		
Maximum supply voltage	V	230		
Power supply frequency	Hz	50		
Rated power	W	197	204	224
Unit current	A	0.91	0.90	0.98
Maximum airflow	m ³ /h	2543	2979	3185
rotation speed at 50hz	-	1320	1390	1446
Sound pressure level LpA at 3 m	dB(A)	34	35	37
Weight	kg	22.8		
Transported air temperature (max)	°C	55		
Transported air temperature (min)	°C	-25		
Ambient air temperature min	°C	1		
Ambient air temperature max	°C	40		
Ingress protection rating	-	IPX4		
Ingress protection rating of the drive	-	IP20		

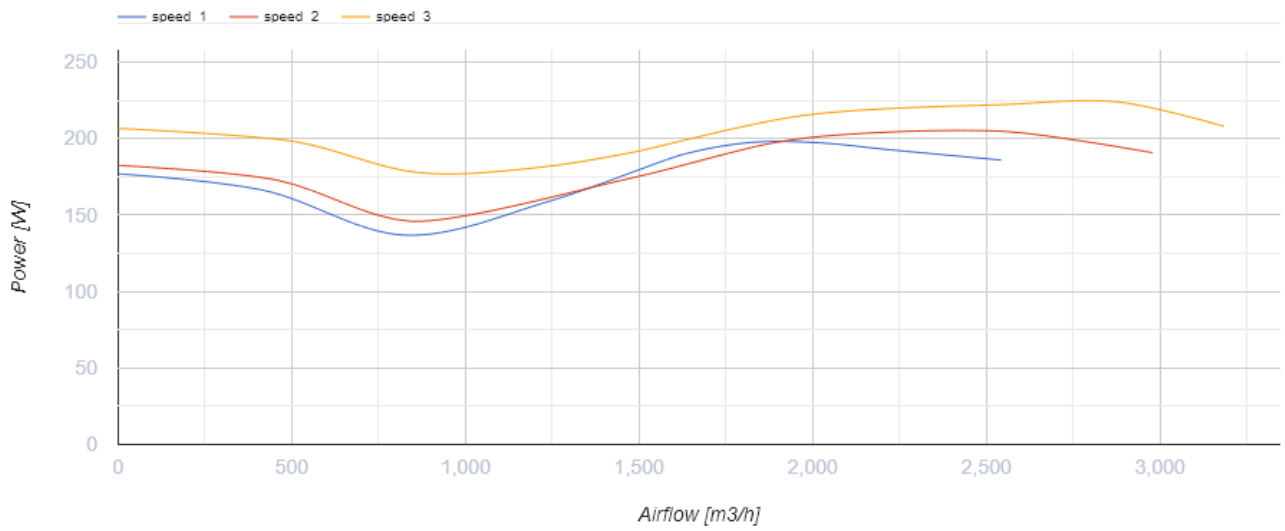
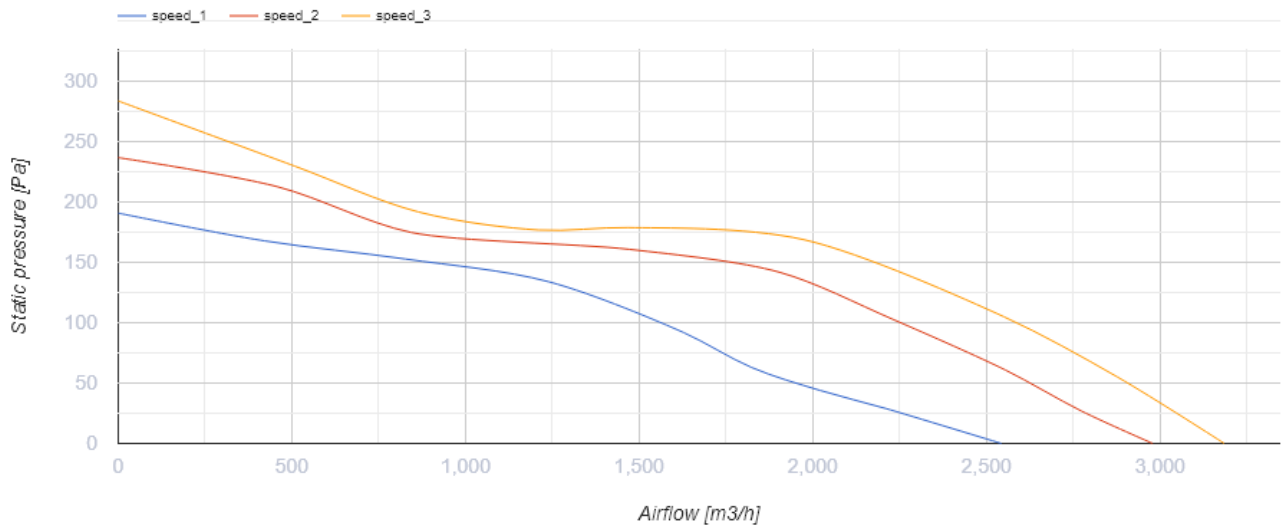

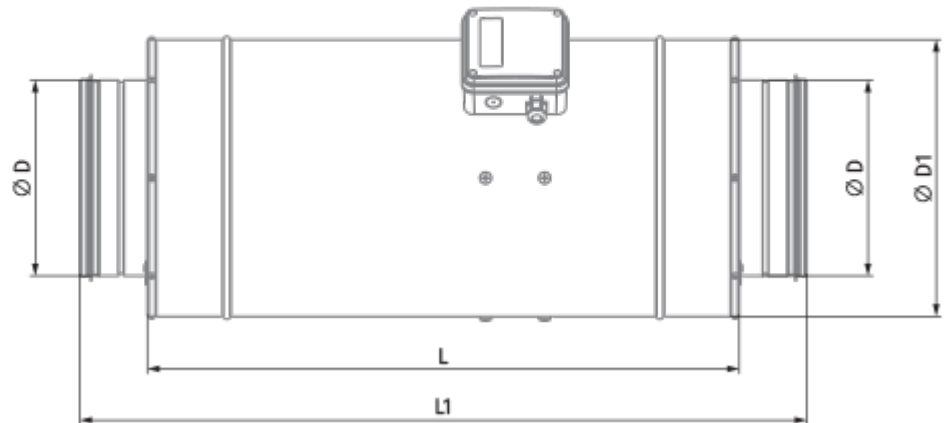
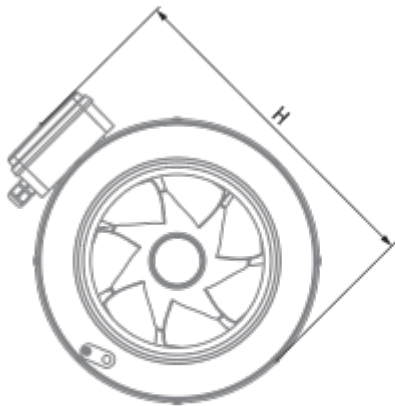

Dimensions

Ø D	Ø D1	H	L	L1
399	460	517	648	785



Accessories

For round ducts

Name	Photo	Description
SD 400/900		Silencers for round ducts
SD 400/1200		Silencers for round ducts

For round ducts

Name	Photo	Description
VKA 400		Air dampers for round ducts

Speed control switches

Name	Photo	Description
CDP-3/5		Multi-speed switch

Thyristor speed controllers

Name	Photo	Description
CDT1 E1.5		Multi-speed switches

CDT E1.8		Thyristor speed controller
CDTE E3.0 TP		Speed controllers