

# Iso-Primo 400 G1

Sound-insulated inline mixed-flow fans



- Maximum airflow: 3185
- Sound pressure level LpA at 3 m: 37
- Sound insulation
- Motor type: AC
- Control: Speed controller
- Impeller type: Mixed-flow
- Casing material: Galvanized steel
- Installation in any position
- Cable with mains plug
- Temperature sensor: Remote

	Unit of measurement	Iso-Primo 400 G1		
Connected air duct size	mm	400		
Speed	-	3		
Phases	-	1		
Minimum supply voltage	V	230		
Maximum supply voltage	V	230		
Power supply frequency	Hz	50		
Rated power	W	197	204	224
Unit current	A	0.91	0.90	0.98
Maximum airflow	m <sup>3</sup> /h	2543	2979	3185
rotation speed at 50hz	-	1320	1390	1446
Sound pressure level LpA at 3 m	dB(A)	34	35	37
Weight	kg	22.8		
Transported air temperature (max)	°C	55		
Transported air temperature (min)	°C	-25		
Ambient air temperature min	°C	1		
Ambient air temperature max	°C	40		
Ingress protection rating	-	IPX4		
Ingress protection rating of the drive	-	IP20		

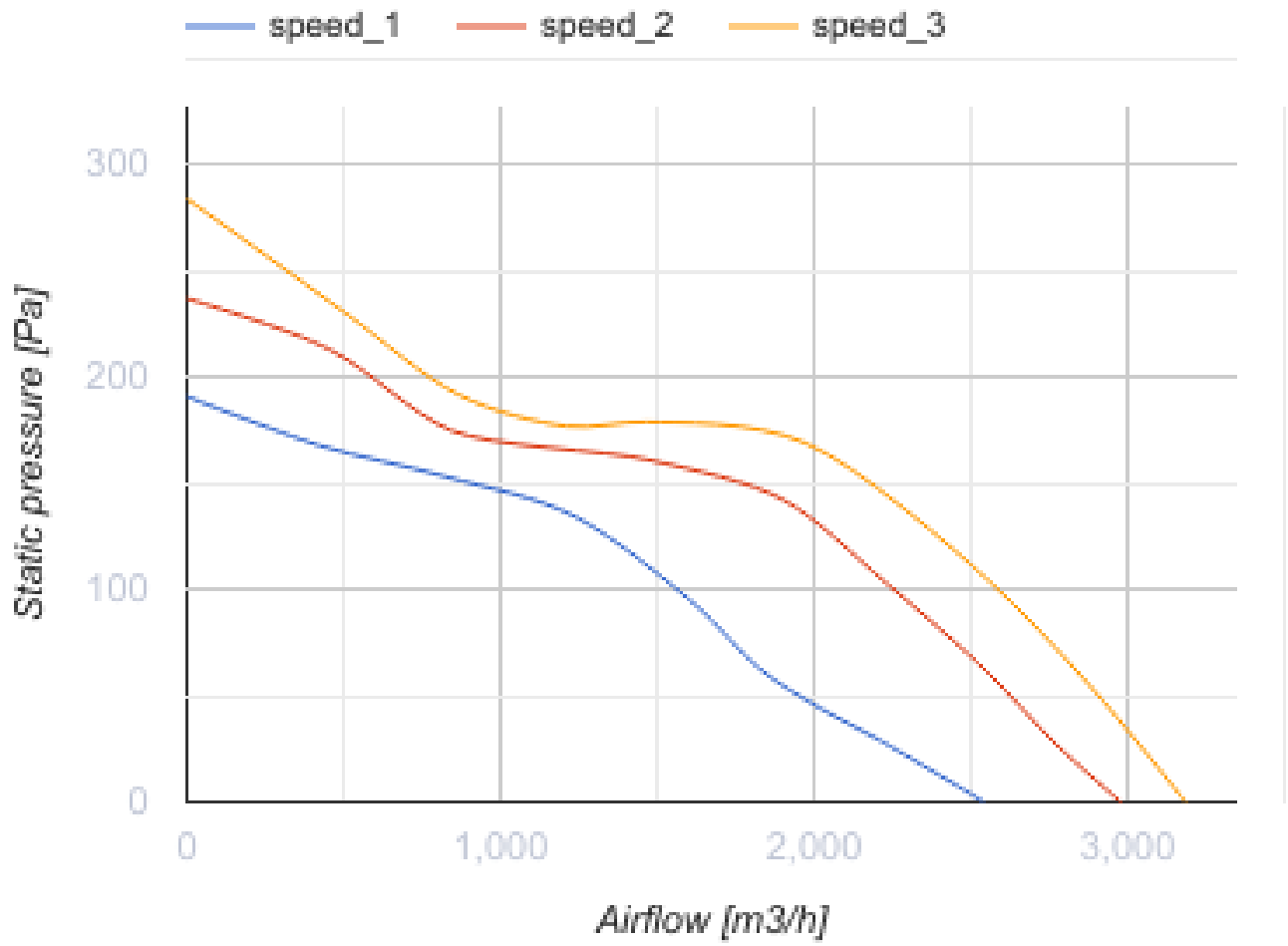

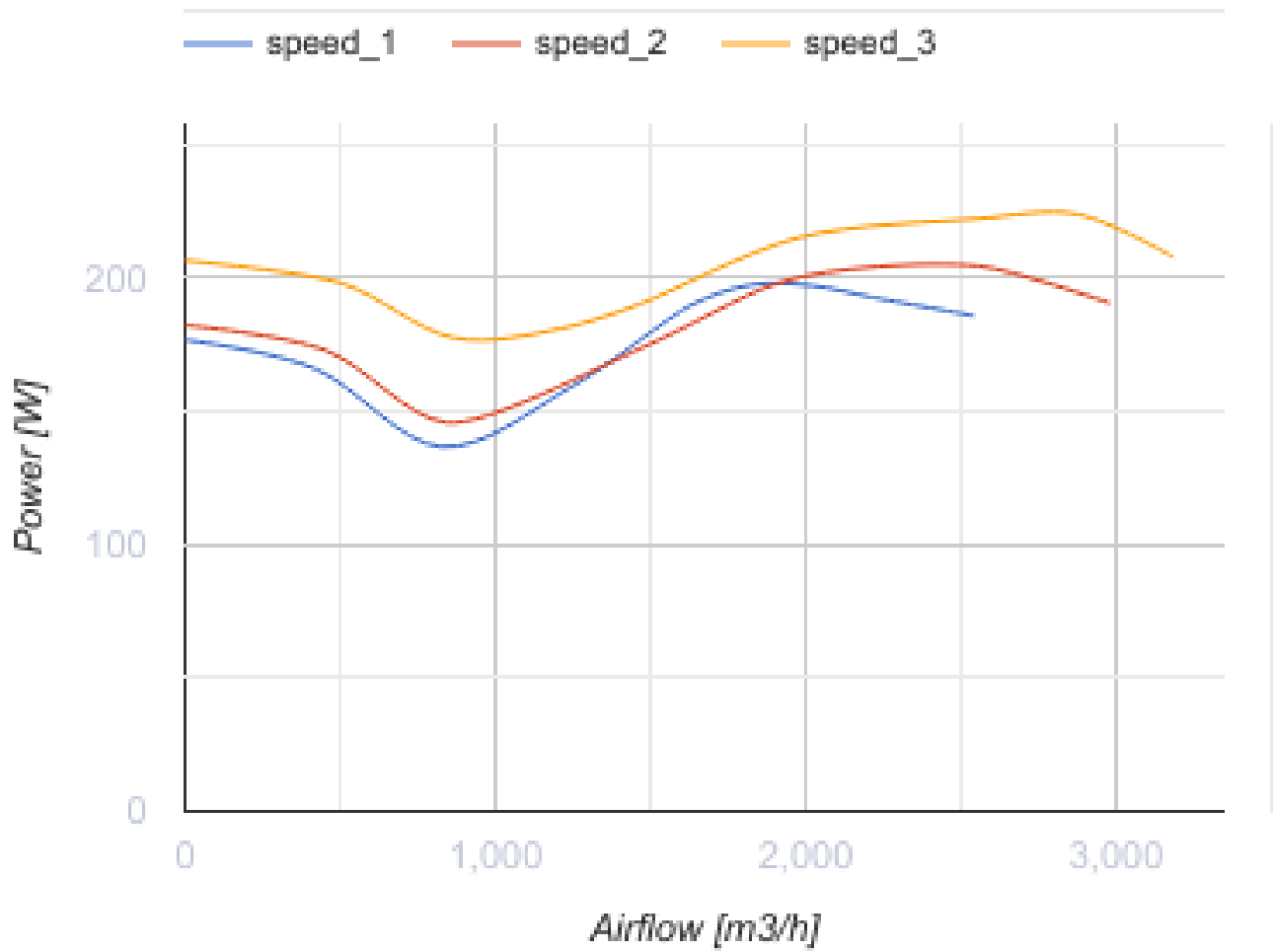

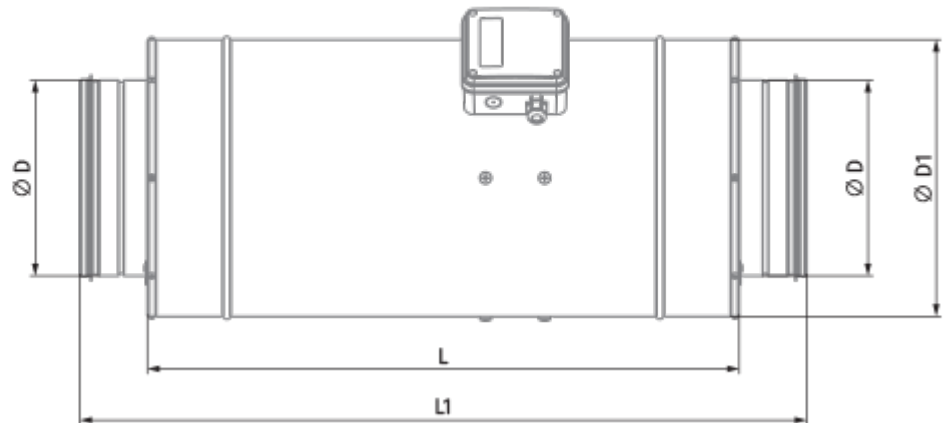
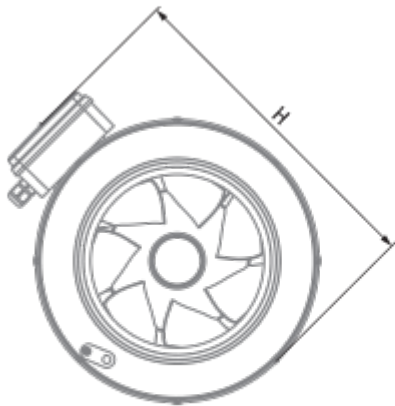

### Dimensions

Ø D	Ø D1	H	L	L1
399	460	517	648	785



## Accessories

### For round ducts

Name	Photo	Description
<a href="#">SD 400/900</a>		Silencers for round ducts
<a href="#">SD 400/1200</a>		Silencers for round ducts

### For round ducts



Name	Photo	Description
<a href="#">VKA 400</a>		Air dampers for round ducts

### Speed control switches

Name	Photo	Description
<a href="#">CDP-3/5</a>		Multi-speed switch

### Thyristor speed controllers

Name	Photo	Description
<a href="#">CDT1 E1.5</a>		Multi-speed switches

<a href="#">CDT E1.8</a>		Thyristor speed controller
<a href="#">CDTE E3.0 TP</a>		Speed controllers