

Iso-Primo 355 G1

Sound-insulated inline mixed-flow fans



- Maximum airflow: 2360
- Sound pressure level LpA at 3 m: 1470
- Sound insulation
- Motor type: AC
- Control: Speed controller
- Impeller type: Mixed-flow
- Casing material: Galvanized steel
- Installation in any position
- Cable with mains plug
- Temperature sensor: Remote

	Unit of measurement	Iso-Primo 355 G1		
Connected air duct size	mm	355		
Speed	-	3		
Phases	-	1		
Minimum supply voltage	V	230		
Maximum supply voltage	V	230		
Power supply frequency	Hz	50		
Rated power	W	126	131	150
Unit current	A	0.60	0.58	0.66
Maximum airflow	m ³ /h	1986	2170	2360
rotation speed at 50hz	-	1350	1400	1470
Sound pressure level LpA at 3 m	dB(A)	1350	1400	1470
Weight	kg	20.7		
Transported air temperature (max)	°C	55		
Transported air temperature (min)	°C	-25		
Ambient air temperature min	°C	1		
Ambient air temperature max	°C	40		
Ingress protection rating	-	IPX4		
Ingress protection rating of the drive	-	IP20		

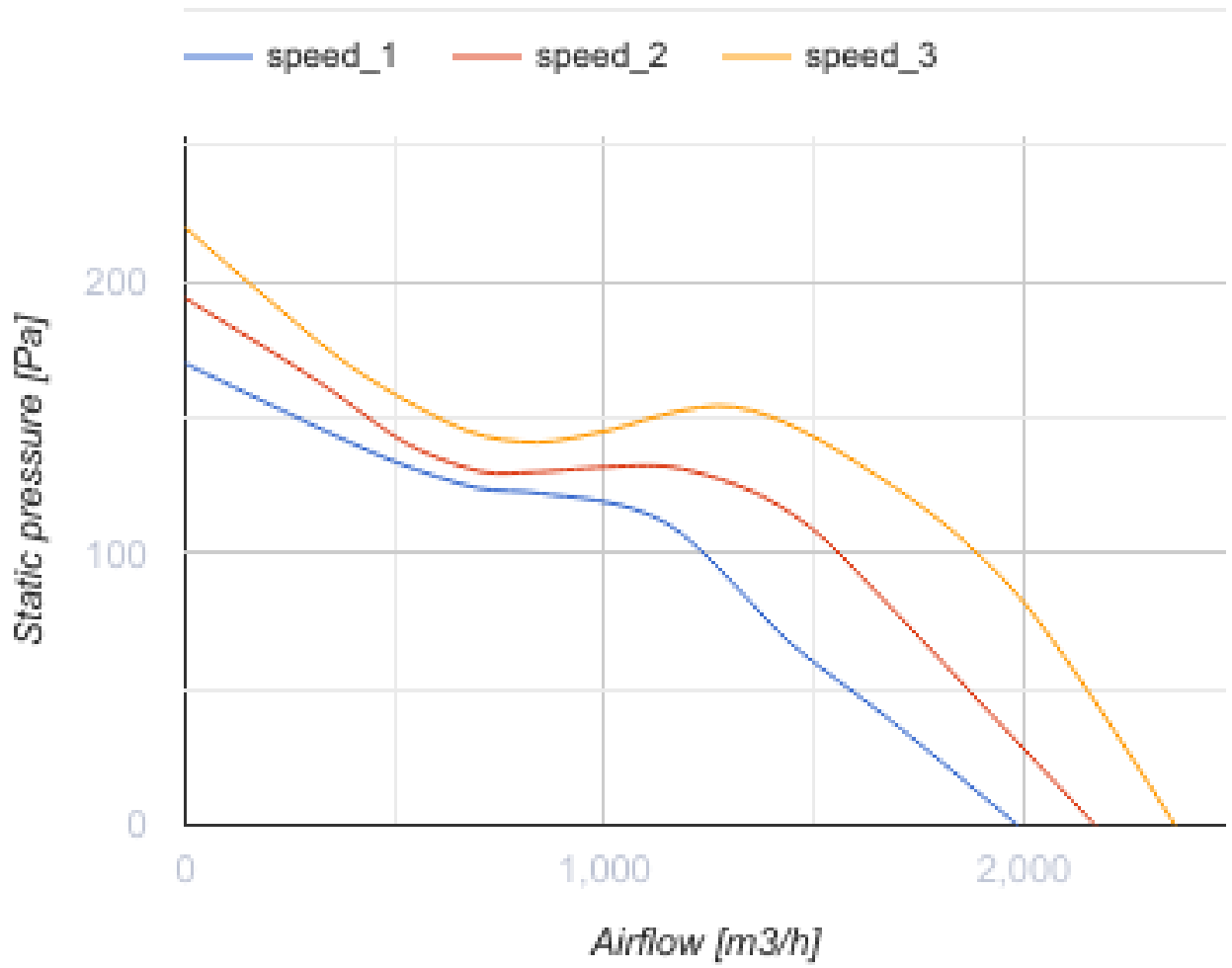

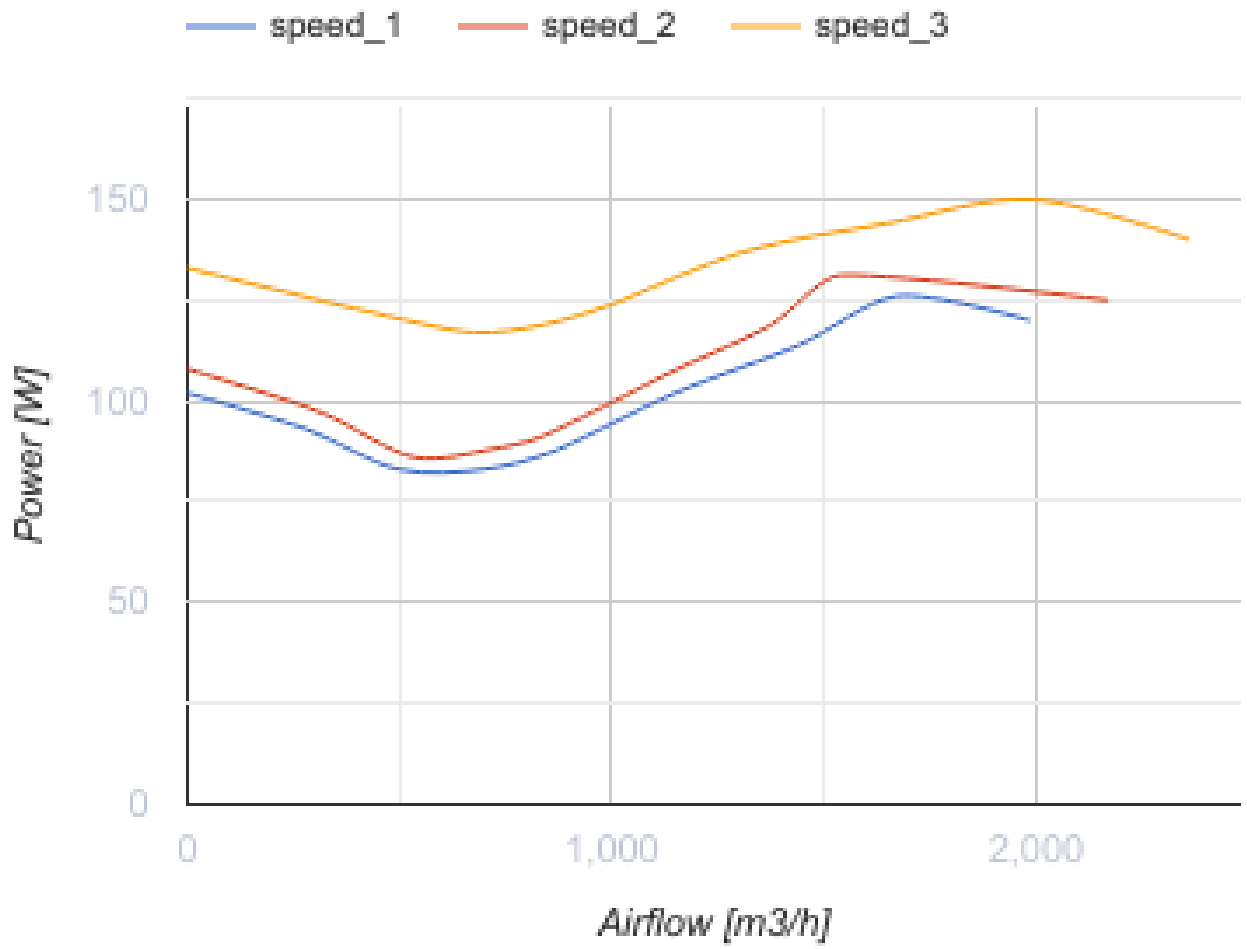

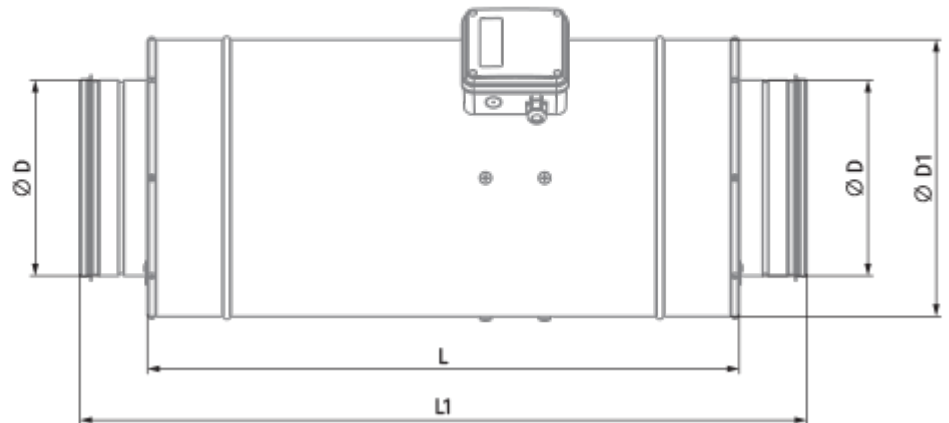
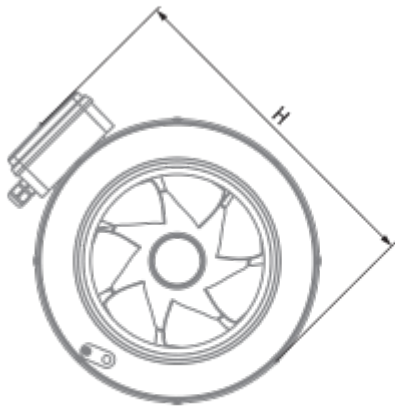

Dimensions

Ø D	Ø D1	H	L	L1
354	412	471	601	739



Accessories

For round ducts

Name	Photo	Description
SD 355/600		Silencers for round ducts
SD 355/900		Silencers for round ducts
SD 355/1200		Silencers for round ducts

For round ducts



Name	Photo	Description
VKA 355		Air dampers for round ducts

Speed control switches

Name	Photo	Description
CDP-3/5		Multi-speed switch

Thyristor speed controllers

Name	Photo	Description
------	-------	-------------

CDT1 E1.5		Multi-speed switches
CDT E1.8		Thyristor speed controller
CDTE E3.0 TP		Speed controllers