

# Iso-Primo 315 US

Mixed-flow inline fans in sound-insulated casings



- Maximum airflow: 2300
- Sound pressure level LpA at 3 m: 36
- Sound insulation
- Motor type: AC
- Control: Speed switch
- Impeller type: Mixed-flow
- Casing material: Galvanized steel
- Installation in any position

	Unit of measurement	Iso-Primo 315 US		
Connected air duct size	mm	315		
Speed	-	3		
Phases	-	1		
Minimum supply voltage	V	230		
Maximum supply voltage	V	230		
Power supply frequency	Hz	50		
Rated power	W	126	131	148
Unit current	A	0.60	0.58	0.66
Maximum airflow	m <sup>3</sup> /h	1913	2120	2300
rotation speed at 50hz	-	1350	1400	1470
Sound pressure level LpA at 3 m	dB(A)	33	34	36
Weight	kg	20.7		
Transported air temperature (max)	°C	55		
Transported air temperature (min)	°C	-25		
Ambient air temperature min	°C	1		
Ambient air temperature max	°C	40		
Ingress protection rating	-	IPX4		
Ingress protection rating of the drive	-	IP20		

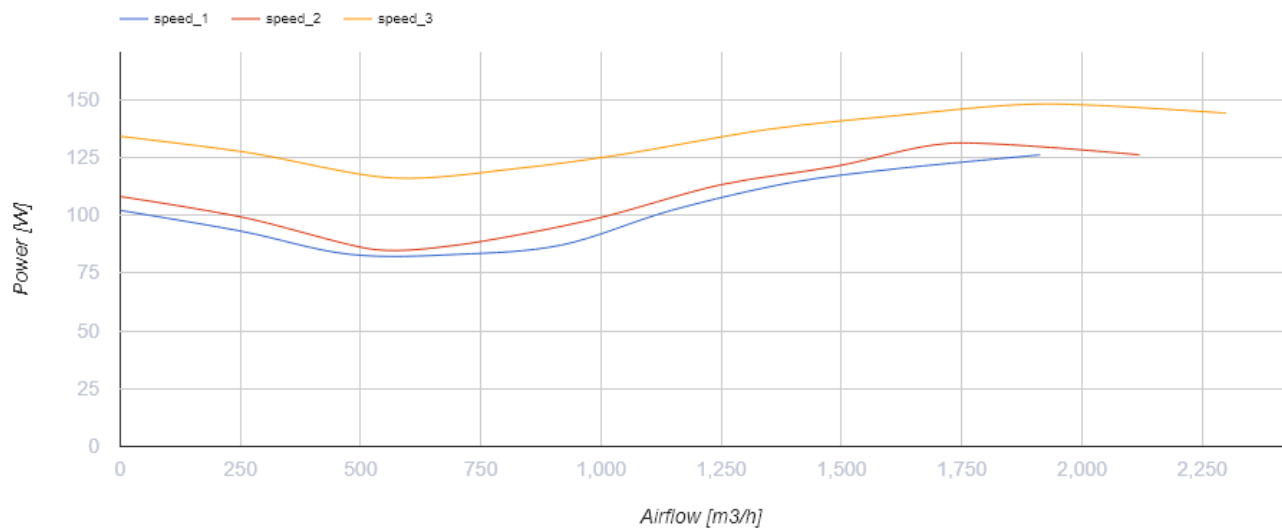
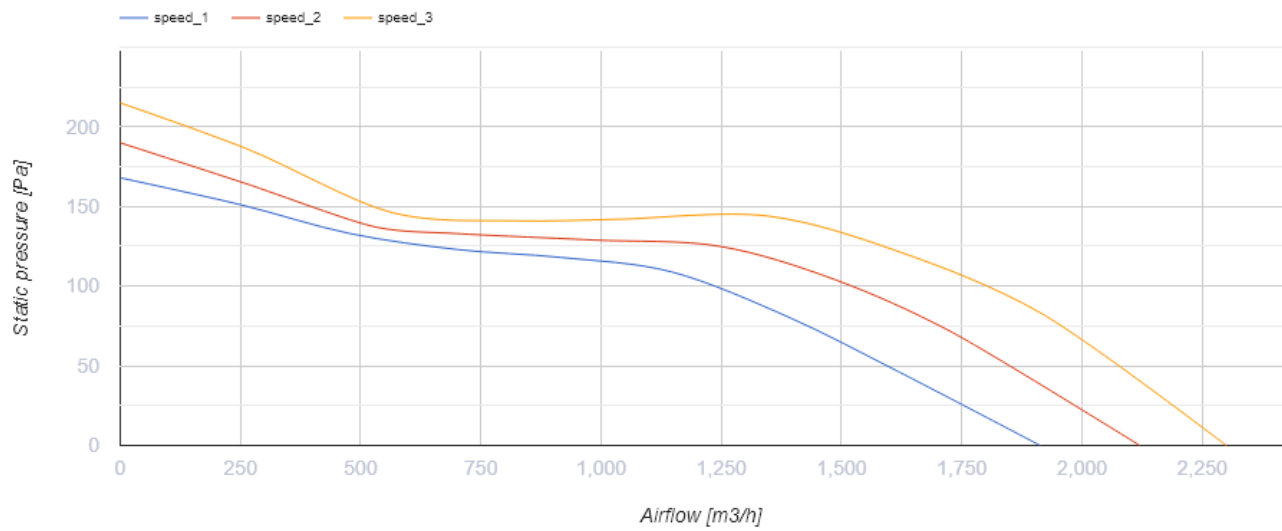

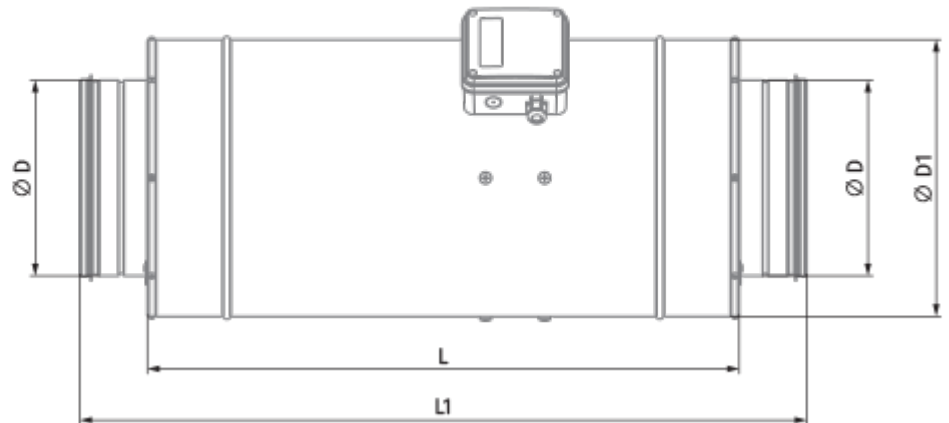
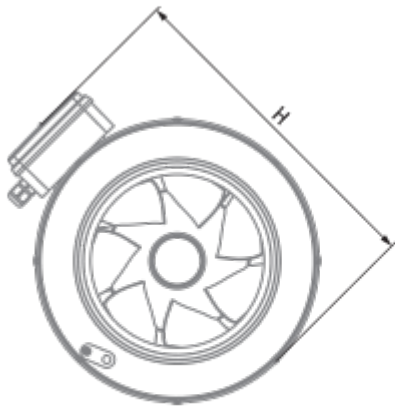

## Dimensions

Ø D	Ø D1	H	L	L1
314	412	468	601	739







## Accessories









### Other accessories

Name	Photo	Description
<a href="#">SD 315/600</a>		Silencers for round ducts
<a href="#">SD 315/900</a>		Silencers for round ducts
<a href="#">SD 315/1200</a>		Silencers for round ducts

### Other accessories

Name	Photo	Description
<a href="#">KFBK 315</a>		Filter boxes for round ducts
<a href="#">KFBT 315 G4</a>		Filter boxes with pocket filters for round ducts
<a href="#">KFBT 315 F5</a>		Filter boxes with pocket filters for round ducts
<a href="#">KFBT 315 F7</a>		Filter boxes with pocket filters for round ducts



### Other accessories

Name	Photo	Description
<a href="#">EKH 315-1.2</a>		Duct electrical heaters for round ducts
<a href="#">EKH 315-2.0</a>		Duct electrical heaters for round ducts
<a href="#">EKH 315-2.4</a>		Duct electrical heaters for round ducts
<a href="#">EKH 315-3.6</a>		Duct electrical heaters for round ducts
<a href="#">EKH 315-6.0</a>		Duct electrical heaters for round ducts
<a href="#">EKH 315-9.0</a>		Duct electrical heaters for round ducts
<a href="#">WKH 315-2</a>		Duct water heaters for round ducts
<a href="#">WKH 315-4</a>		Duct water heaters for round ducts

#### Other accessories

Name	Photo	Description
<a href="#">VRV 315</a>		Backdraft dampers with spring for round ducts
<a href="#">VKA 315</a>		Air dampers for round ducts

#### Other accessories

Name	Photo	Description
<a href="#">CDP-3/5</a>		Multi-speed switch
<a href="#">CDT1 E1.5</a>		Multi-speed switches

<a href="#">CDT E1.8</a>		Thyristor speed controller
<a href="#">CDTE E3.0 TP</a>		Speed controllers