

Iso-Primo 315 T

Sound-insulated inline mixed-flow fans



- Maximum airflow: 2300
- Sound pressure level LpA at 3 m: 36
- Sound insulation
- Motor type: AC
- Impeller type: Mixed
- Casing material: Galvanized steel
- Installation in any position
- Timer: Turn off timer

	Unit of measurement	Iso-Primo 315 T		
Connected air duct size	mm	315		
Speed	-	3		
Phases	-	1		
Minimum supply voltage	V	230		
Maximum supply voltage	V	230		
Power supply frequency	Hz	50		
Rated power	W	126	131	148
Unit current	A	0.60	0.58	0.66
Maximum airflow	m ³ /h	1913	2120	2300
rotation speed at 50hz	-	1350	1400	1470
Sound pressure level LpA at 3 m	dB(A)	33	34	36
Weight	kg	20.7		
Transported air temperature (max)	°C	55		
Transported air temperature (min)	°C	-25		
Ambient air temperature min	°C	1		
Ambient air temperature max	°C	40		
Ingress protection rating	-	IPX4		
Ingress protection rating of the drive	-	IP20		

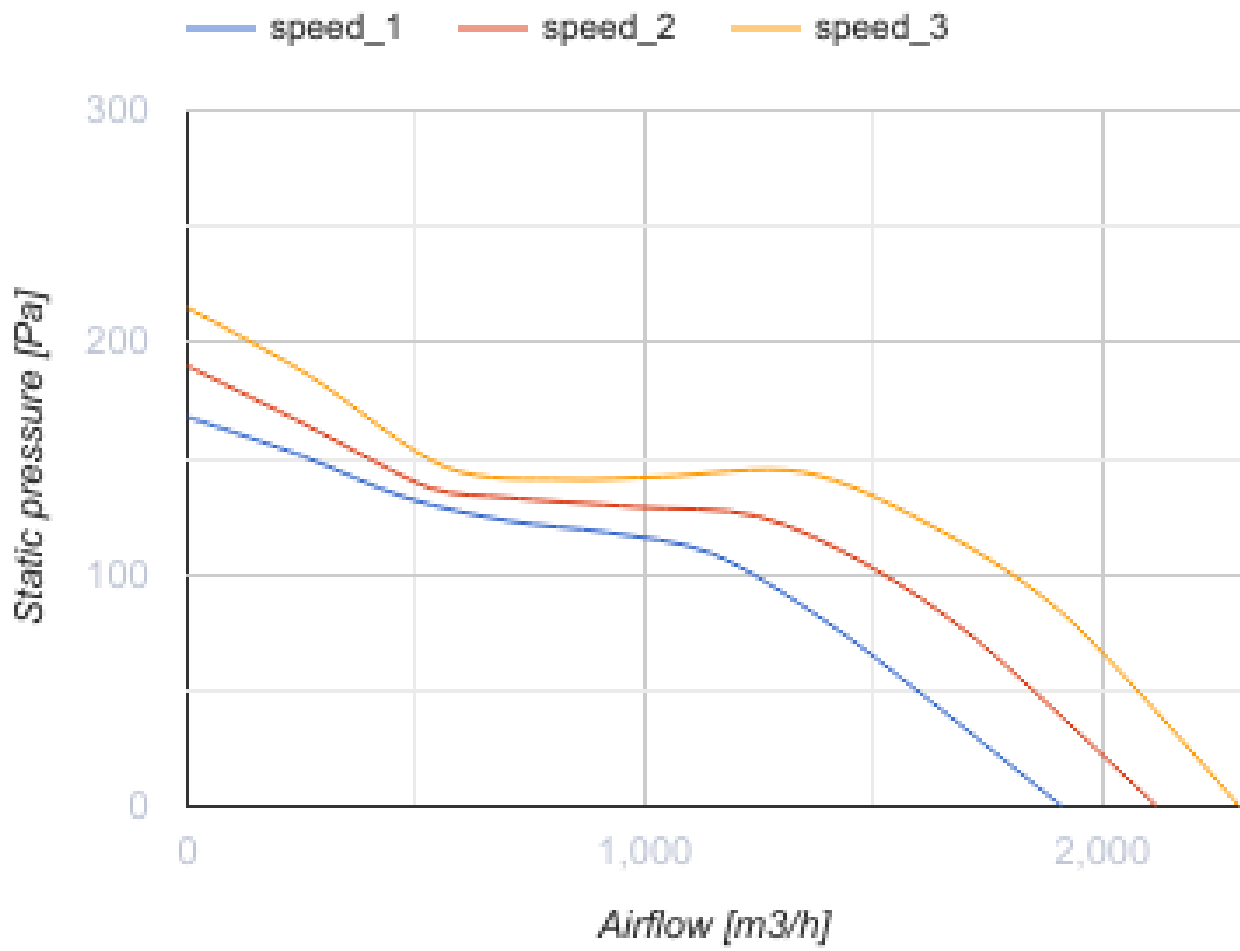

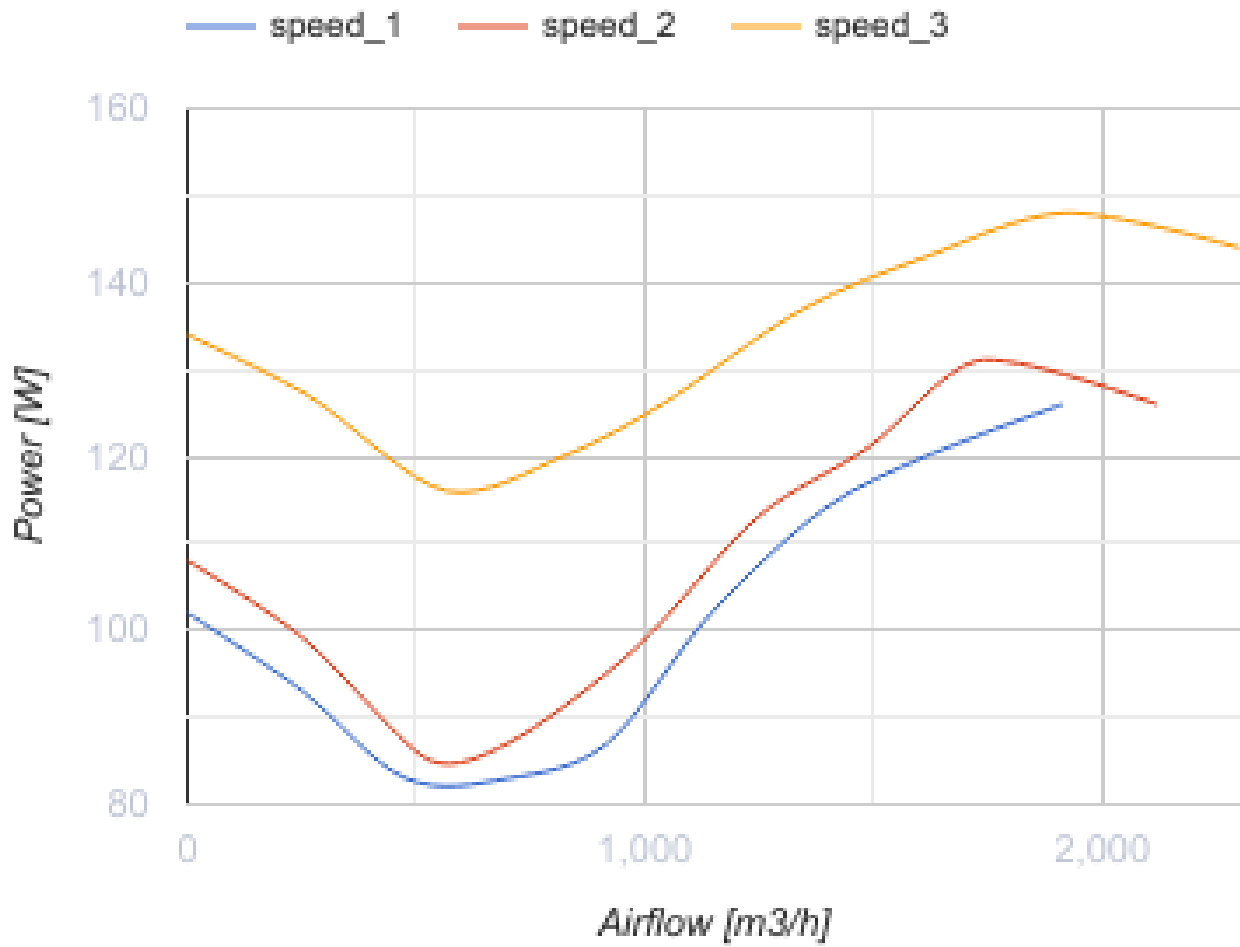

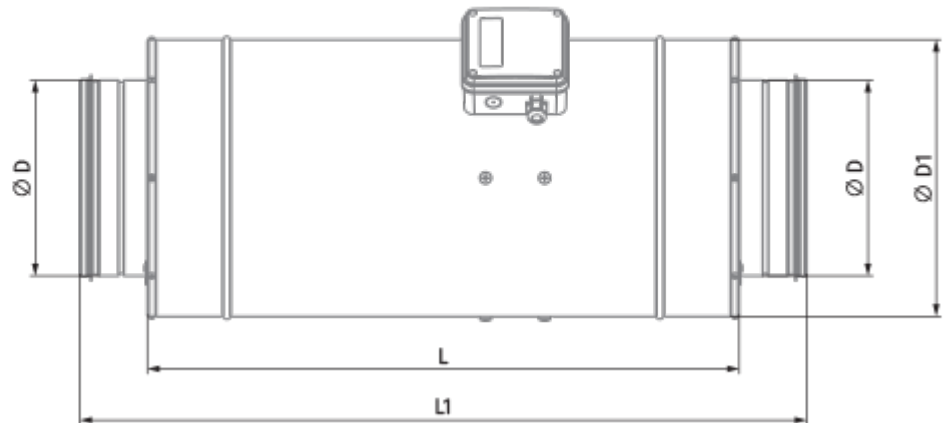
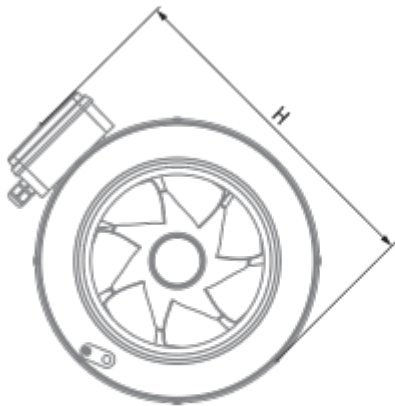

Dimensions

Ø D	Ø D1	H	L	L1
314	412	468	601	739







Accessories









Other accessories

Name	Photo	Description
SD 315/600		Silencers for round ducts
SD 315/900		Silencers for round ducts
SD 315/1200		Silencers for round ducts

Other accessories

Name	Photo	Description
KFBK 315		Filter boxes for round ducts
KFBT 315 G4		Filter boxes with pocket filters for round ducts
KFBT 315 F5		Filter boxes with pocket filters for round ducts
KFBT 315 F7		Filter boxes with pocket filters for round ducts



Other accessories



Name	Photo	Description
EKH 315-1.2		Duct electrical heaters for round ducts
EKH 315-2.0		Duct electrical heaters for round ducts
EKH 315-2.4		Duct electrical heaters for round ducts
EKH 315-3.6		Duct electrical heaters for round ducts
EKH 315-6.0		Duct electrical heaters for round ducts
EKH 315-9.0		Duct electrical heaters for round ducts
WKH 315-2		Duct water heaters for round ducts
WKH 315-4		Duct water heaters for round ducts

Other accessories

Name	Photo	Description
VRV 315		Backdraft dampers with spring for round ducts
VKA 315		Air dampers for round ducts

Other accessories

Name	Photo	Description
CDP-3/5		Multi-speed switch
CDT1 E1.5		Multi-speed switches

CDT E1.8		Thyristor speed controller
CDTE E3.0 TP		Speed controllers