

# Iso-Primo 315

Mixed-flow inline fans in sound-insulated casings



- Maximum airflow: 2300
- Sound pressure level LpA at 3 m: 36
- Sound insulation
- Motor type: AC
- Impeller type: Mixed-flow
- Casing material: Galvanized steel
- Installation in any position

|  | Unit of measurement | Iso-Primo 315 |      |      |
|--|---------------------|---------------|------|------|
| Connected air duct size                | mm                  | 315           |      |      |
| Speed                                  | -                   | 3             |      |      |
| Phases                                 | -                   | 1             |      |      |
| Minimum supply voltage                 | V                   | 230           |      |      |
| Maximum supply voltage                 | V                   | 230           |      |      |
| Power supply frequency                 | Hz                  | 50            |      |      |
| Rated power                            | W                   | 126           | 131  | 148  |
| Unit current                           | A                   | 0.60          | 0.58 | 0.66 |
| Maximum airflow                        | m <sup>3</sup> /h   | 1913          | 2120 | 2300 |
| rotation speed at 50hz                 | -                   | 1350          | 1400 | 1470 |
| Sound pressure level LpA at 3 m        | dB(A)               | 33            | 34   | 36   |
| Weight                                 | kg                  | 20.7          |      |      |
| Transported air temperature (max)      | °C                  | 55            |      |      |
| Transported air temperature (min)      | °C                  | -25           |      |      |
| Ambient air temperature min            | °C                  | 1             |      |      |
| Ambient air temperature max            | °C                  | 40            |      |      |
| Ingress protection rating              | -                   | IPX4          |      |      |
| Ingress protection rating of the drive | -                   | IP20          |      |      |

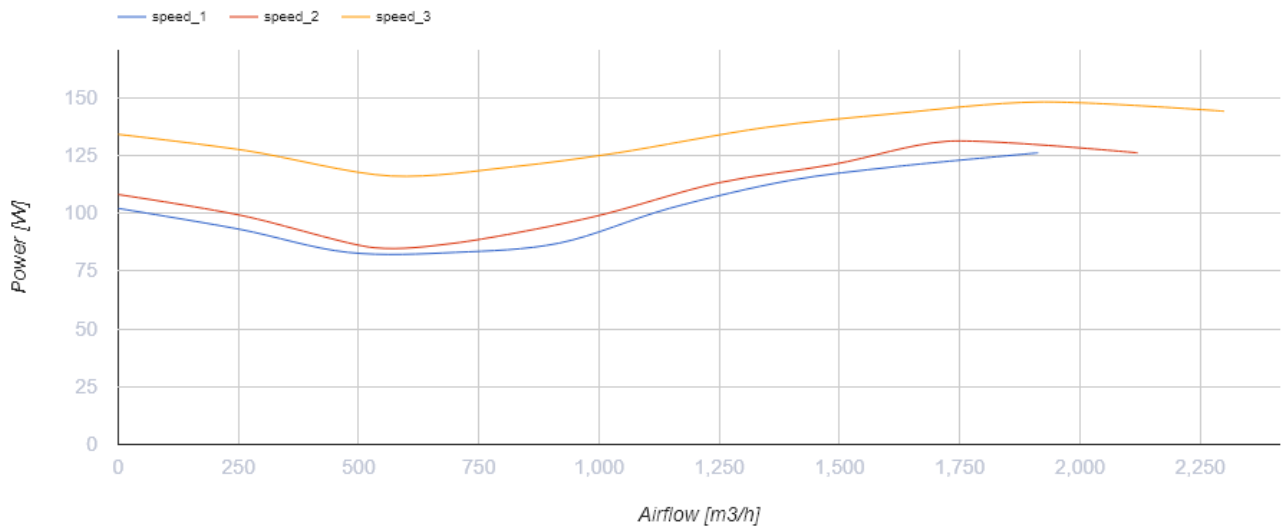
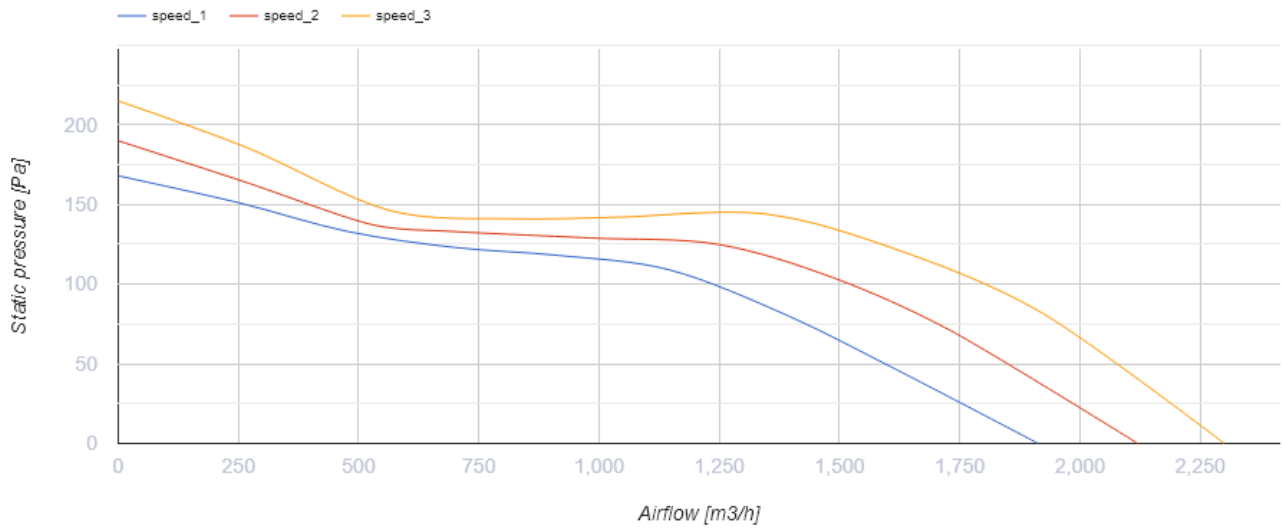

## Dimensions

| Ø D | Ø D1 | H   | L   | L1  |
|-----|------|-----|-----|-----|
| 314 | 412  | 468 | 601 | 739 |

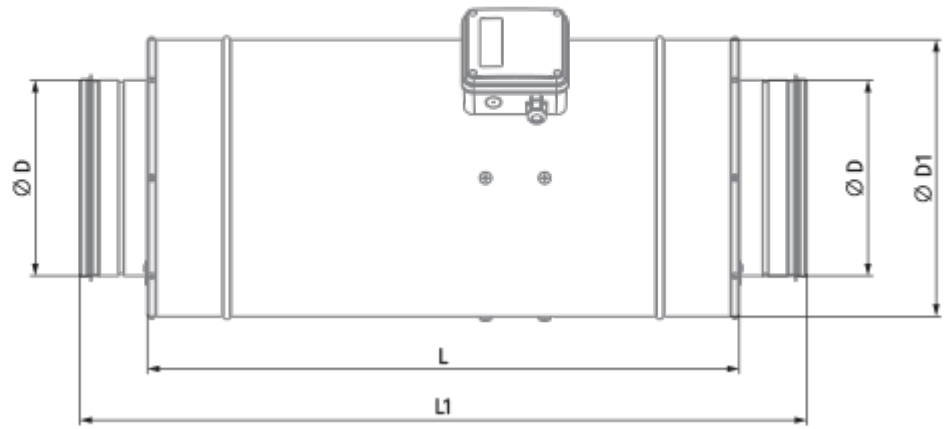
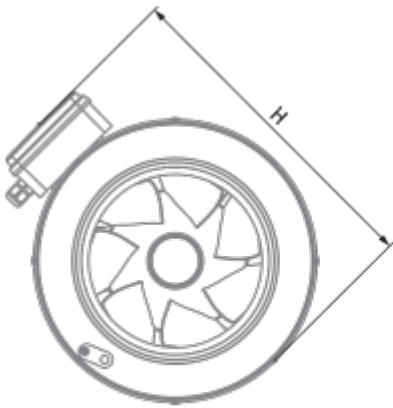



## Ecodesign

|                                       |                |
|---------------------------------------|----------------|
| Trademark                             | Blauberg       |
| Model                                 | Iso-Primo 315  |
| Type of ventilation unit              | Unidirectional |
| Type of drive installed               | Integrated VSD |
| Type of heat recovery system          | None           |
| Nominal flow rate (m <sup>3</sup> /s) | 0.374          |
| Nominal external pressure (Pa)        | 144            |
| Maximum external leakage rates (%)    | 2.7            |
| Static efficiency (%)                 | 40.1           |
| Effective electric power input (kW)   | 0.137          |
| Sound power level (dB(A))             | 57             |
| Declared typology                     | NRVU UVU       |



## Accessories

### Other accessories



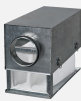





| Name                        | Photo   | Description               |
|-----------------------------|---|---------------------------|
| <a href="#">SD 315/600</a>  |  | Silencers for round ducts |
| <a href="#">SD 315/900</a>  |  | Silencers for round ducts |
| <a href="#">SD 315/1200</a> |  | Silencers for round ducts |

### Other accessories



| Name                        | Photo   | Description                                      |
|-----------------------------|---|--|
| <a href="#">KFBK 315</a>    |  | Filter boxes for round ducts                     |
| <a href="#">KFBT 315 G4</a> |  | Filter boxes with pocket filters for round ducts |

|                             |   |  |
|-----------------------------|---|--|
| <a href="#">KFBT 315 F5</a> |  | Filter boxes with pocket filters for round ducts |
| <a href="#">KFBT 315 F7</a> |  | Filter boxes with pocket filters for round ducts |





### Other accessories

| Name                        | Photo   | Description                             |
|-----------------------------|---|---|
| <a href="#">EKH 315-1.2</a> |    | Duct electrical heaters for round ducts |
| <a href="#">EKH 315-2.0</a> |    | Duct electrical heaters for round ducts |
| <a href="#">EKH 315-2.4</a> |    | Duct electrical heaters for round ducts |
| <a href="#">EKH 315-3.6</a> |  | Duct electrical heaters for round ducts |
| <a href="#">EKH 315-6.0</a> |  | Duct electrical heaters for round ducts |
| <a href="#">EKH 315-9.0</a> |  | Duct electrical heaters for round ducts |
| <a href="#">WKH 315-2</a>   |  | Duct water heaters for round ducts      |
| <a href="#">WKH 315-4</a>   |  | Duct water heaters for round ducts      |

### Other accessories

| Name                    | Photo   | Description                                   |
|-------------------------|---|---|
| <a href="#">VRV 315</a> |  | Backdraft dampers with spring for round ducts |
| <a href="#">VKA 315</a> |  | Air dampers for round ducts                   |

### Other accessories

| Name                         | Photo   | Description                |
|------------------------------|---|----------------------------|
| <a href="#">CDP-3/5</a>      |  | Multi-speed switch         |
| <a href="#">CDT1 E1.5</a>    |  | Multi-speed switches       |
| <a href="#">CDT E1.8</a>     |  | Thyristor speed controller |
| <a href="#">CDTE E3.0 TP</a> |  | Speed controllers          |