

Iso-Primo 250 US

Sound-insulated inline mixed-flow fans



- Maximum airflow: 1670
- Sound pressure level LpA at 3 m: 45
- Sound insulation
- Motor type: AC
- Control: Speed switch
- Impeller type: Mixed-flow
- Casing material: Galvanized steel
- Installation in any position

	Unit of measurement	Iso-Primo 250 US		
Connected air duct size	mm	250		
Speed	-	3		
Phases	-	1		
Minimum supply voltage	V	230		
Maximum supply voltage	V	230		
Power supply frequency	Hz	50		
Rated power	W	144	173	188
Unit current	A	0.70	0.81	0.84
Maximum airflow	m ³ /h	1007	1404	1670
rotation speed at 50hz	-	2292	2626	2876
Sound pressure level LpA at 3 m	dB(A)	38	43	45
Weight	kg	9.8		
Transported air temperature (max)	°C	55		
Transported air temperature (min)	°C	-25		
Ambient air temperature min	°C	1		
Ambient air temperature max	°C	40		
Ingress protection rating	-	IPX4		
Ingress protection rating of the drive	-	IP20		

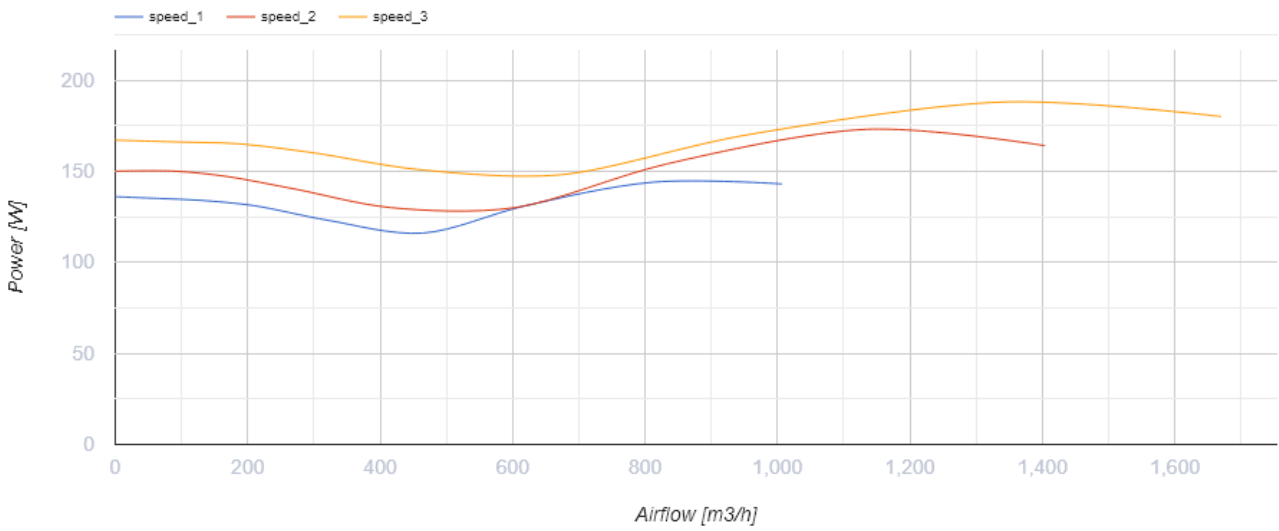
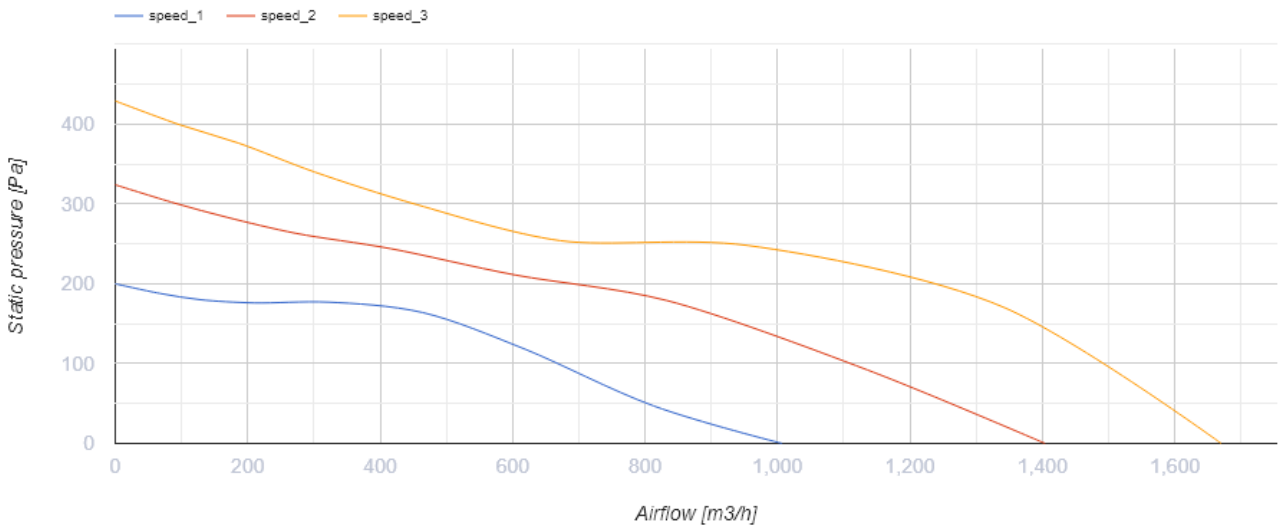

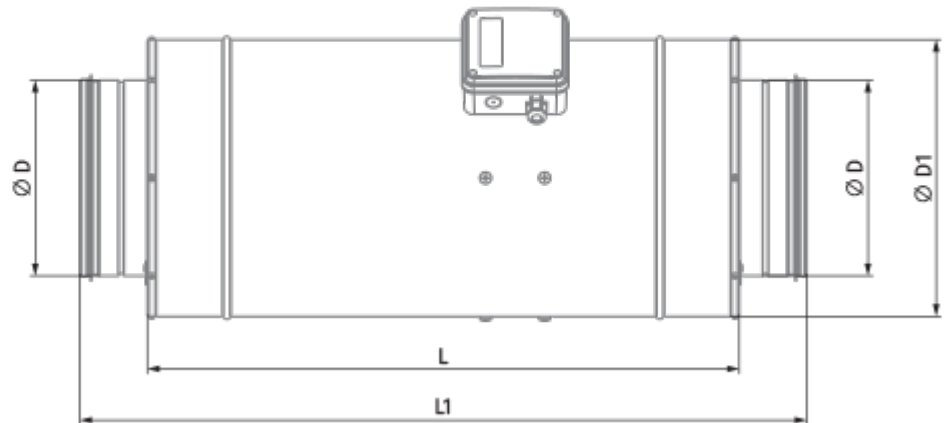
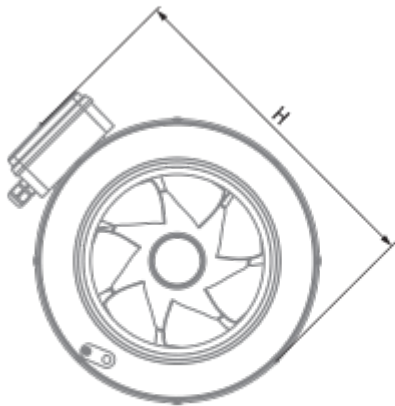

Dimensions

ØD	ØD1	H	L	L1
249	337	389	601	739







Accessories







For round ducts

Name	Photo	Description
SD 250/600		Silencers for round ducts
SD 250/900		Silencers for round ducts
SD 250/1200		Silencers for round ducts



For round ducts

Name	Photo	Description
KFBK 250		Filter boxes for round ducts
KFBT 250 G4		Filter boxes with pocket filters for round ducts
KFBT 250 F5		Filter boxes with pocket filters for round ducts
KFBT 250 F7		Filter boxes with pocket filters for round ducts

Electrical heaters

Name	Photo	Description
EKH 250-1.2		Duct electrical heaters for round ducts
EKH 250-2.0		Duct electrical heaters for round ducts
EKH 250-2.4		Duct electrical heaters for round ducts
EKH 250-3.0		Duct electrical heaters for round ducts
EKH 250-3.6		Duct electrical heaters for round ducts
EKH 250-6.0		Duct electrical heaters for round ducts
EKH 250-9.0		Duct electrical heaters for round ducts

Water heaters

Name	Photo	Description
WKH 250-2		Duct water heaters for round ducts
WKH 250-4		Duct water heaters for round ducts

For round ducts



Name	Photo	Description
VRV 250		Backdraft dampers with spring for round ducts
VKA 250		Air dampers for round ducts

Speed control switches

Name	Photo	Description
------	-------	-------------

CDP-3/5		Multi-speed switch
-------------------------	---	--------------------

Thyristor speed controllers

Name	Photo	Description
CDT1 E1.5		Multi-speed switches
CDT E1.8		Thyristor speed controller
CDTE E3.0 TP		Speed controllers