

Iso-Primo 200 US

Mixed-flow inline fans in sound-insulated casings



- Maximum airflow: 1110
- Sound pressure level LpA at 3 m: 44
- Sound insulation
- Motor type: AC
- Control: Speed switch
- Impeller type: Mixed-flow
- Casing material: Galvanized steel
- Installation in any position

	Unit of measurement	Iso-Primo 200 US		
Connected air duct size	mm	200		
Speed	-	3		
Phases	-	1		
Minimum supply voltage	V	230		
Maximum supply voltage	V	230		
Power supply frequency	Hz	50		
Rated power	W	82	104	113
Unit current	A	0.37	0.46	0.51
Maximum airflow	m ³ /h	692	906	1110
rotation speed at 50hz	-	2229	2634	2823
Sound pressure level LpA at 3 m	dB(A)	37	42	44
Weight	kg	8.2		
Transported air temperature (max)	°C	55		
Transported air temperature (min)	°C	-25		
Ambient air temperature min	°C	1		
Ambient air temperature max	°C	40		
Ingress protection rating	-	IPX4		
Ingress protection rating of the drive	-	IP20		

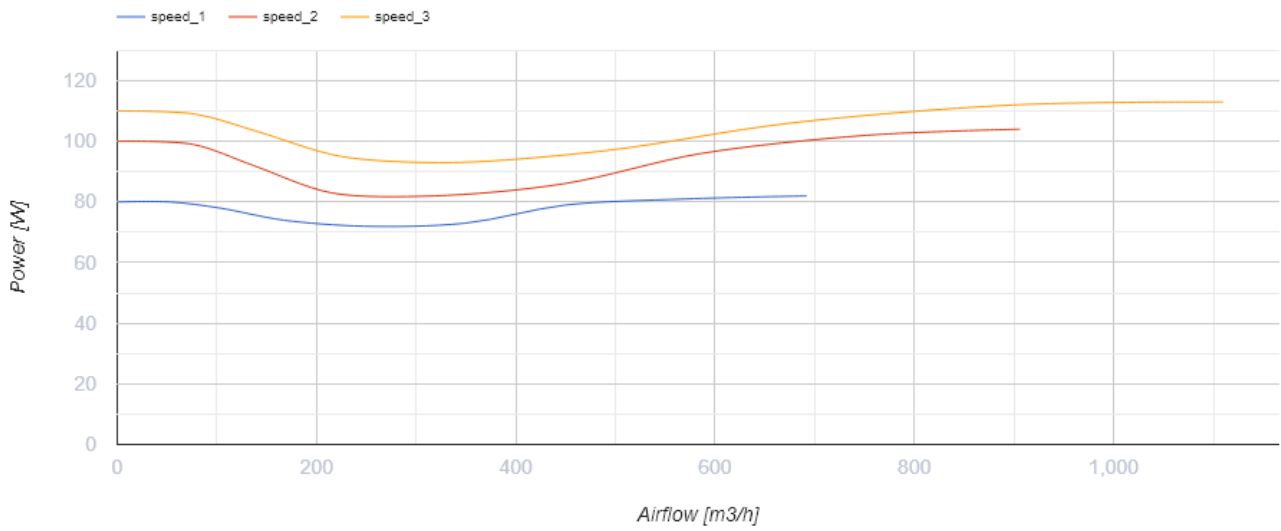
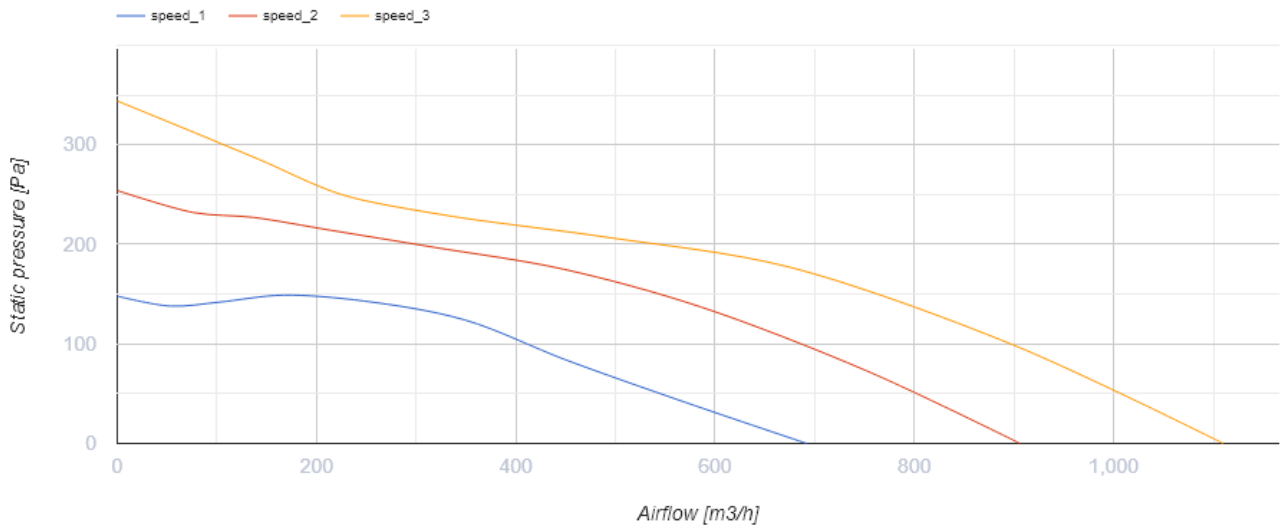

Dimensions

ØD	ØD1	H	L	L1
199	281	339	601	739

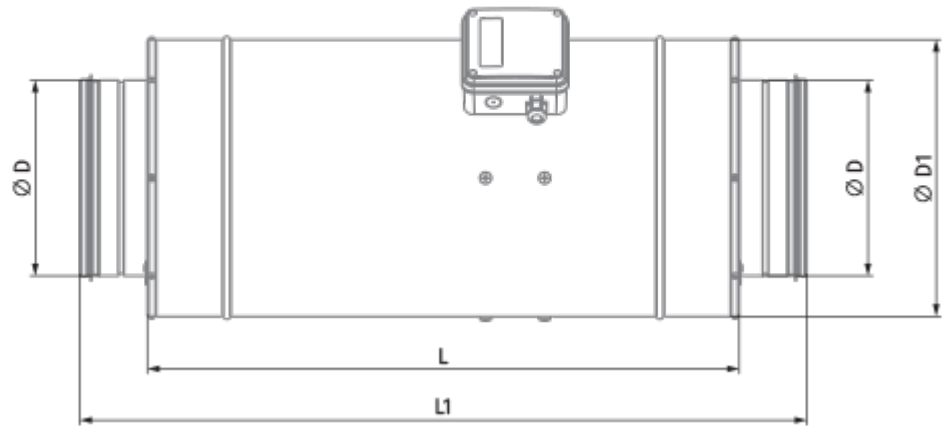
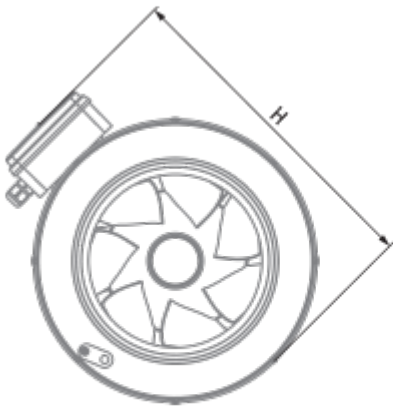



Ecodesign



Trademark	Blauberg
Model	Iso-Primo 200 US
Type of drive installed	Integrated VSD
Type of heat recovery system	None
Nominal flow rate (m ³ /s)	0.188
Nominal external pressure (Pa)	177
Maximum external leakage rates (%)	2.7
Static efficiency (%)	31.9
Effective electric power input (kW)	0.106
Sound power level (dB(A))	62
Declared typology	NRVU UVU



Accessories

Other accessories











Name	Photo	Description
SD 200/600		Silencers for round ducts
SD 200/900		Silencers for round ducts
SD 200/1200		Silencers for round ducts

Other accessories

Name	Photo	Description
KFBK 200		Filter boxes for round ducts
KFBT 200 G4		Filter boxes with pocket filters for round ducts



KFBT 200 F5		Filter boxes with pocket filters for round ducts
KFBT 200 F7		Filter boxes with pocket filters for round ducts

Other accessories





Name	Photo	Description
EKH 200-1.2		Duct electrical heaters for round ducts
EKH 200-1.7		Duct electrical heaters for round ducts
EKH 200-2.0		Duct electrical heaters for round ducts
EKH 200-2.4		Duct electrical heaters for round ducts
EKH 200-3.4		Duct electrical heaters for round ducts
EKH 200-3.6		Duct electrical heaters for round ducts
EKH 200-5.1		Duct electrical heaters for round ducts
EKH 200-6.0		Duct electrical heaters for round ducts
WKH 200-2		Duct water heaters for round ducts
WKH 200-4		Duct water heaters for round ducts

Other accessories

Name	Photo	Description
------	-------	-------------

VRV 200		Backdraft dampers with spring for round ducts
VKA 200		Air dampers for round ducts

Other accessories

Name	Photo	Description
CDP-3/5		Multi-speed switch
CDT1 E1.5		Multi-speed switches
CDT E1.8		Thyristor speed controller
CDTE E3.0 TP		Speed controllers