

# Iso-Primo 200

Mixed-flow inline fans in sound-insulated casings



- Maximum airflow: 1110
- Sound pressure level LpA at 3 m: 44
- Sound insulation
- Motor type: AC
- Impeller type: Mixed-flow
- Casing material: Galvanized steel
- Installation in any position

	Unit of measurement	Iso-Primo 200		
Connected air duct size	mm	200		
Speed	-	3		
Phases	-	1		
Minimum supply voltage	V	230		
Maximum supply voltage	V	230		
Power supply frequency	Hz	50		
Rated power	W	82	104	113
Unit current	A	0.37	0.46	0.51
Maximum airflow	m <sup>3</sup> /h	692	906	1110
rotation speed at 50hz	-	2229	2634	2823
Sound pressure level LpA at 3 m	dB(A)	37	42	44
Weight	kg	8.2		
Transported air temperature (max)	°C	55		
Transported air temperature (min)	°C	-25		
Ambient air temperature min	°C	1		
Ambient air temperature max	°C	40		
Ingress protection rating	-	IPX4		
Ingress protection rating of the drive	-	IP20		

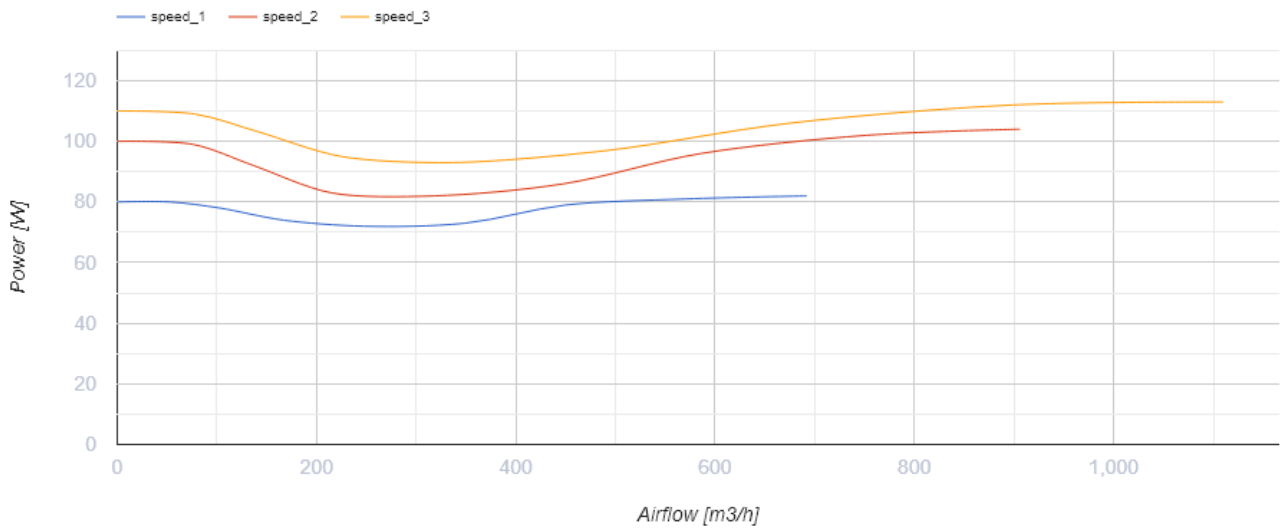
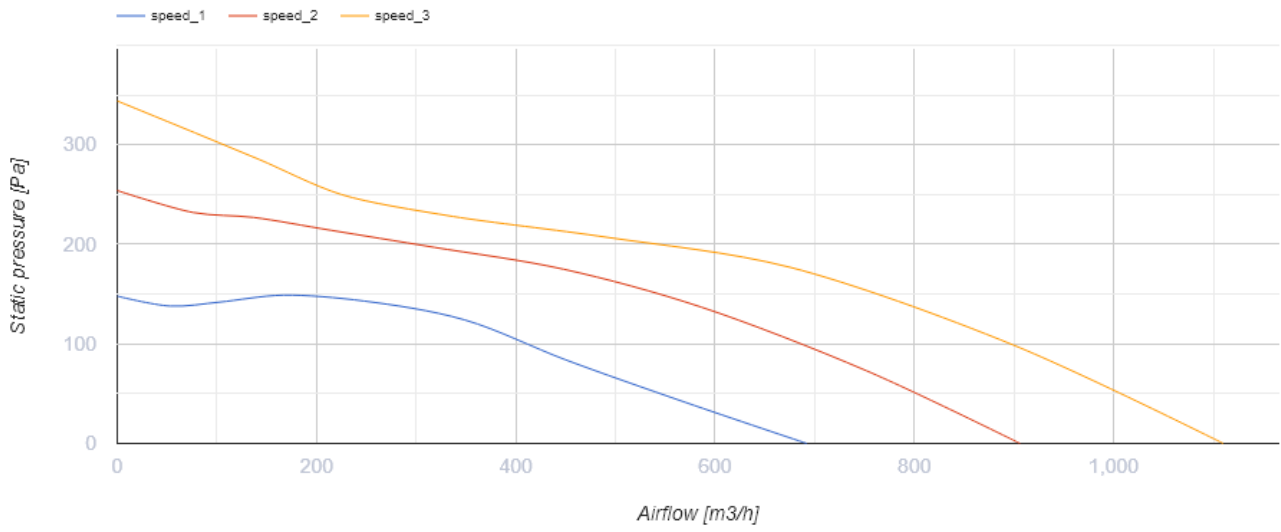

## Dimensions

ØD	ØD1	H	L	L1
199	281	339	601	739

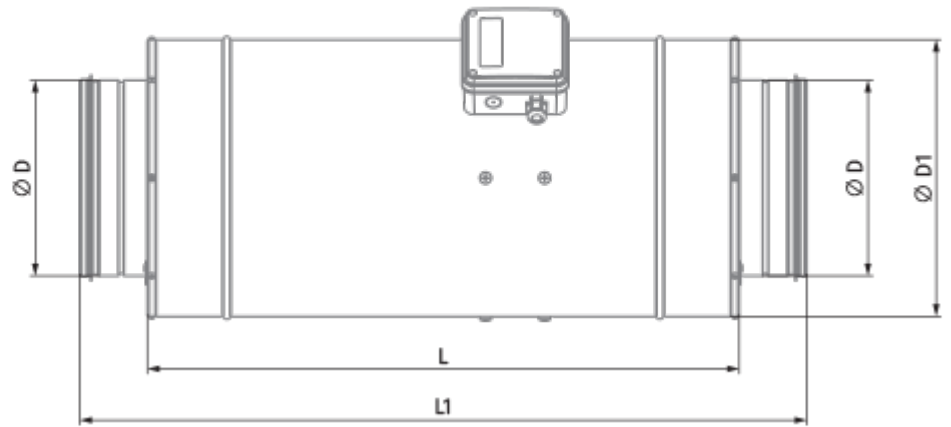
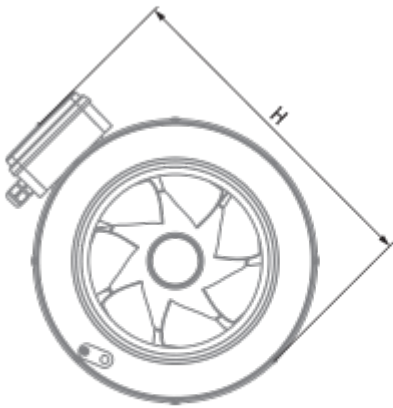





## Ecodesign

Trademark	Blauberg
Model	Iso-Primo 200
Type of ventilation unit	Unidirectional
Type of drive installed	Integrated VSD
Type of heat recovery system	None
Nominal flow rate (m <sup>3</sup> /s)	0.188
Nominal external pressure (Pa)	177
Maximum external leakage rates (%)	2.7
Static efficiency (%)	31.9
Declared typology	NRVU UVU
Effective electric power input (kW)	0.106
Sound power level (dB(A))	62









## Accessories

### Other accessories



Name	Photo	Description
<a href="#">CDP-3/5</a>		Multi-speed switch
<a href="#">CDT E1.8</a>		Thyristor speed controller
<a href="#">CDT1 E1.5</a>		Multi-speed switches
<a href="#">CDTE E3.0 TP</a>		Speed controllers

### Other accessories

Name	Photo	Description
<a href="#">EKH 200-6.0</a>		Duct electrical heaters for round ducts





<a href="#">EKH 200-5.1</a>		Duct electrical heaters for round ducts
<a href="#">EKH 200-3.6</a>		Duct electrical heaters for round ducts
<a href="#">EKH 200-3.4</a>		Duct electrical heaters for round ducts
<a href="#">EKH 200-2.4</a>		Duct electrical heaters for round ducts
<a href="#">EKH 200-2.0</a>		Duct electrical heaters for round ducts
<a href="#">EKH 200-1.7</a>		Duct electrical heaters for round ducts
<a href="#">EKH 200-1.2</a>		Duct electrical heaters for round ducts
<a href="#">WKH 200-2</a>		Duct water heaters for round ducts
<a href="#">WKH 200-4</a>		Duct water heaters for round ducts

### Other accessories

Name	Photo	Description
<a href="#">SD 200/600</a>		Silencers for round ducts
<a href="#">SD 200/900</a>		Silencers for round ducts
<a href="#">SD 200/1200</a>		Silencers for round ducts

### Other accessories

Name	Photo	Description
------	-------	-------------

<a href="#">KFBK 200</a>		Filter boxes for round ducts
<a href="#">KFBT 200 G4</a>		Filter boxes with pocket filters for round ducts
<a href="#">KFBT 200 F5</a>		Filter boxes with pocket filters for round ducts
<a href="#">KFBT 200 F7</a>		Filter boxes with pocket filters for round ducts

### Other accessories

Name	Photo	Description
<a href="#">VRV 200</a>		Backdraft dampers with spring for round ducts
<a href="#">VKA 200</a>		Air dampers for round ducts