

Iso-Mix EC 250 G1

Mixed-flow inline fans in sound-insulated casings with EC-motors



- Maximum airflow: 1285
- Sound pressure level LpA at 3 m: 42
- Sound insulation
- Motor type: EC
- Control: Built-in speed controller
- Impeller type: Mixed-flow
- Casing material: Coated steel
- Installation in any position
- Cable with mains plug
- Temperature sensor

	Unit of measurement	Iso-Mix EC 250 G1
Connected air duct size	mm	250
Speed	-	1
Minimum supply voltage	V	230
Maximum supply voltage	V	230
Power supply frequency	Hz	50/60
Rated power	W	169
Unit current	A	1.38
Maximum airflow	m ³ /h	1285
Sound pressure level LpA at 3 m	dB(A)	42
Weight	kg	12.5
Transported air temperature (max)	°C	55
Transported air temperature (min)	°C	-25
Ingress protection rating	-	IPX4

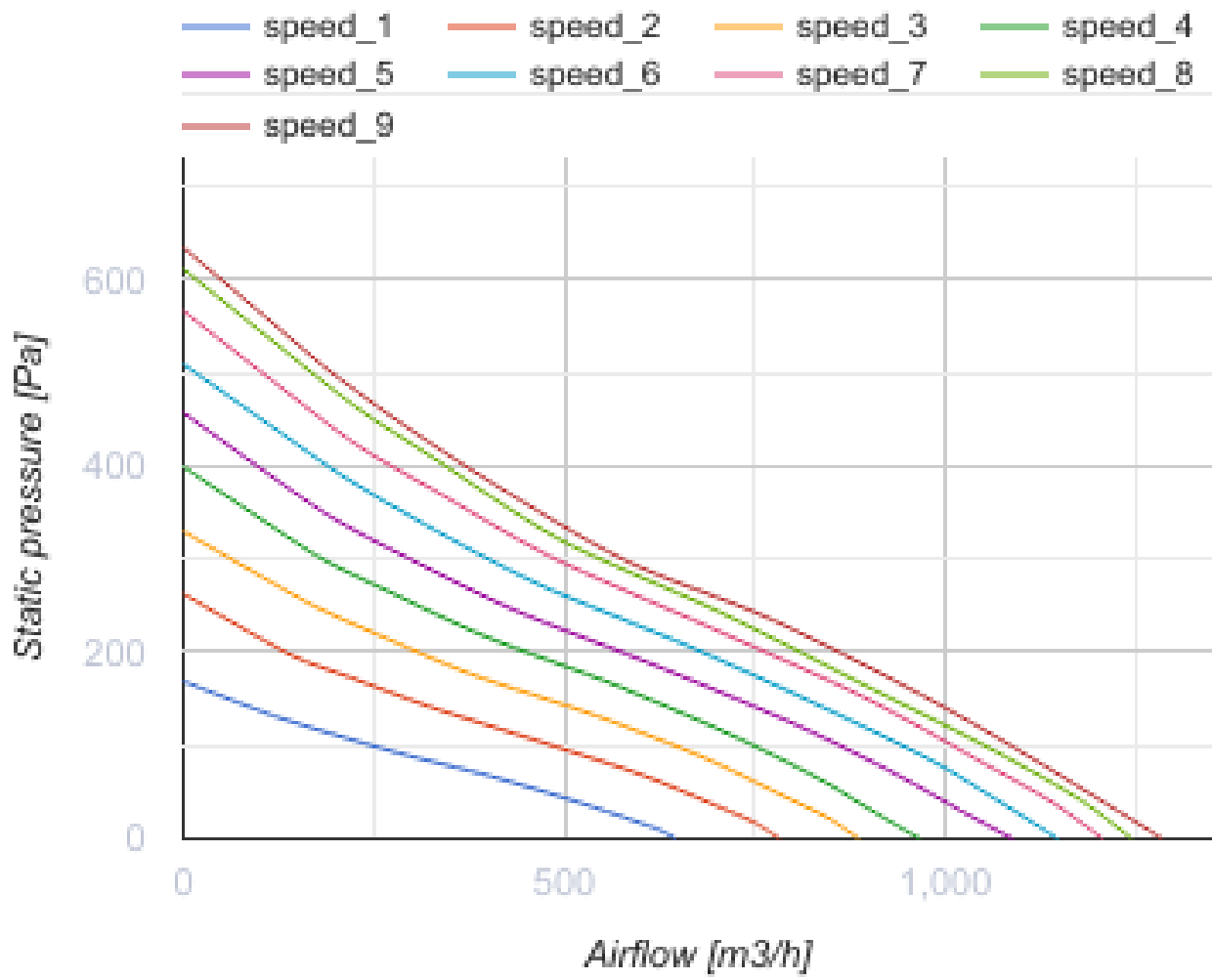

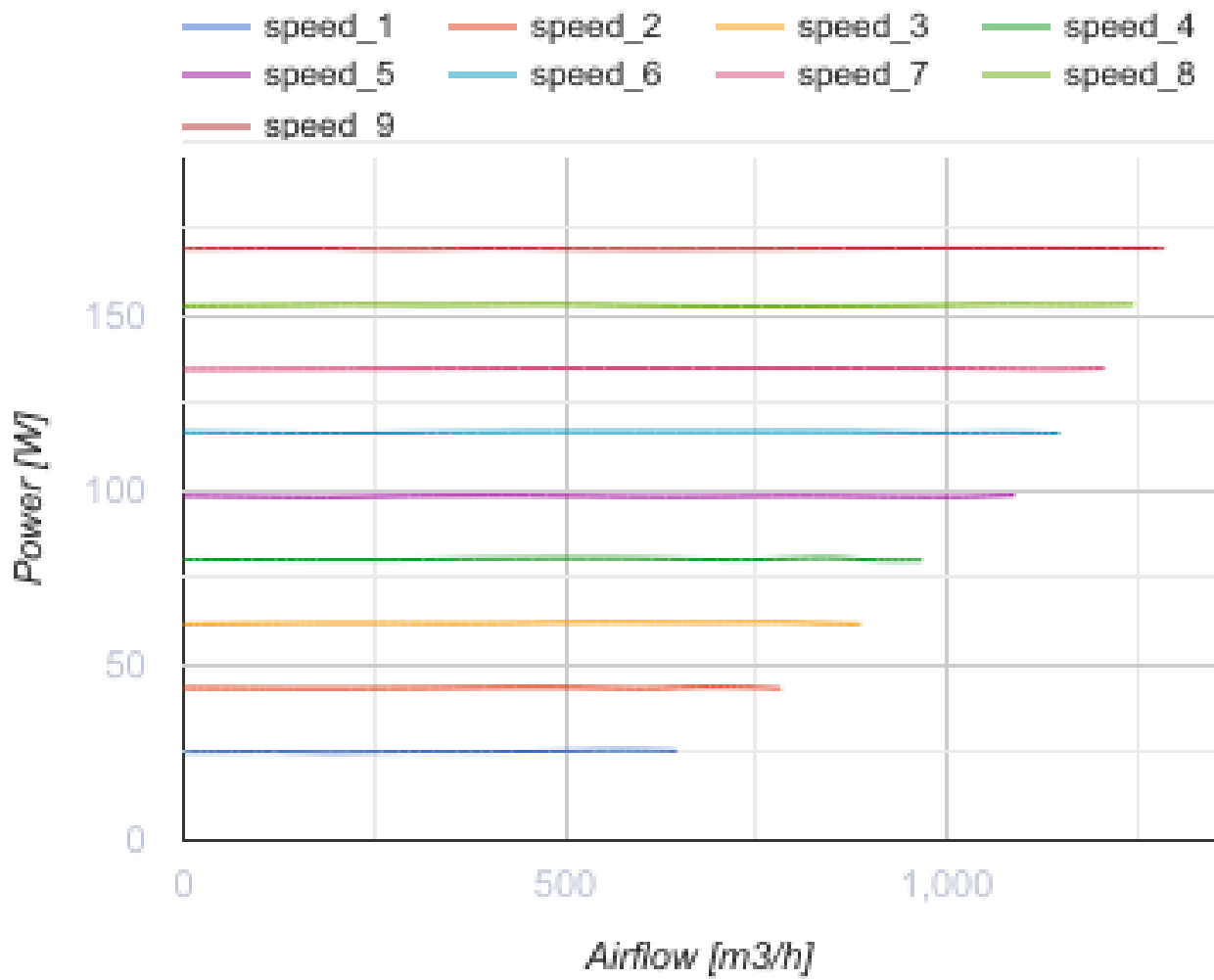

Dimensions

ØD	H	L	L1	W	W1
248	360	665	130	445	370

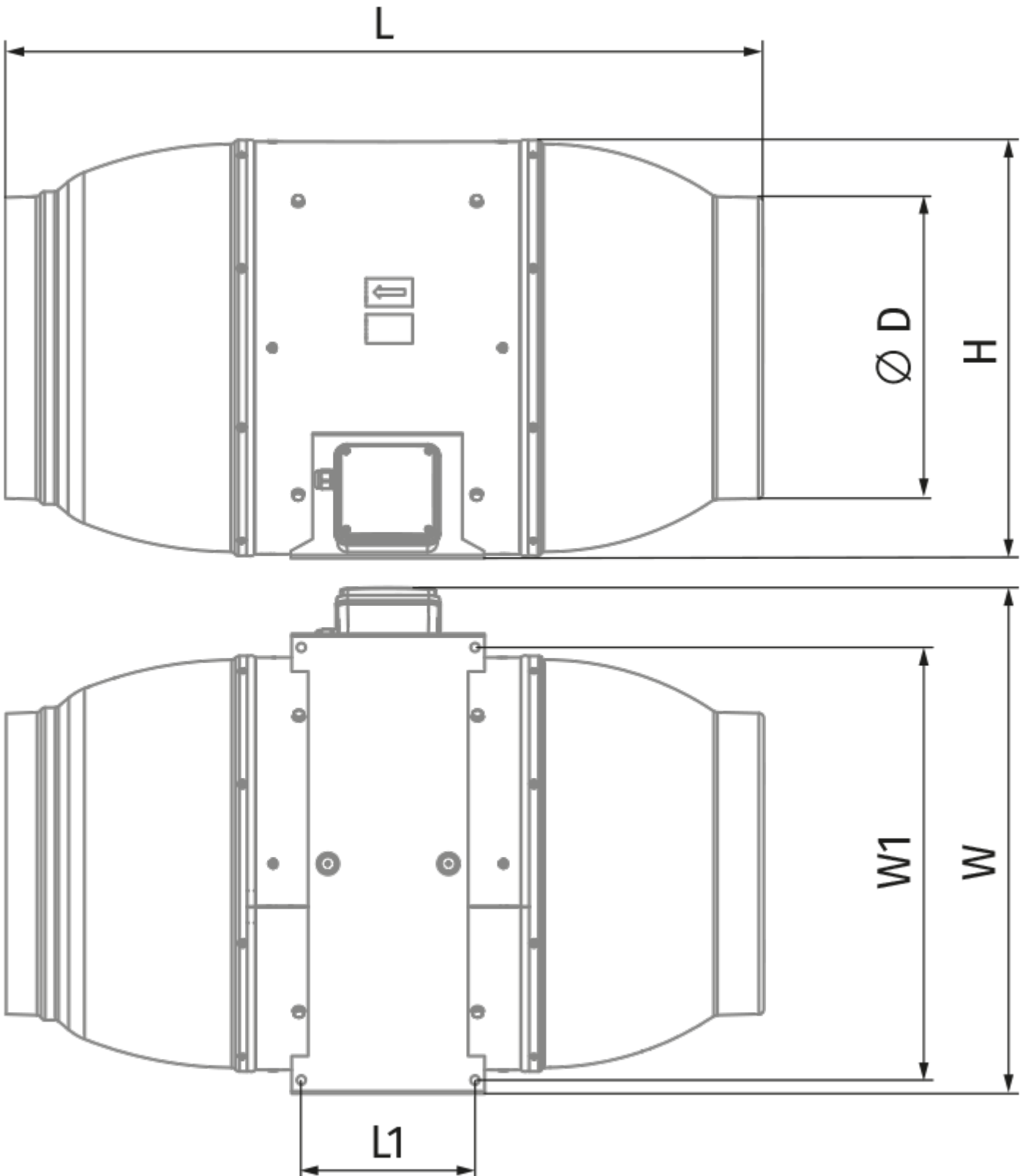

Ecodesign

Trademark	Blauberg
Model	Iso-Mix EC 250 G1
Type of ventilation unit	Unidirectional
Type of drive installed	Integrated VSD
Type of heat recovery system	None
Nominal flow rate (m ³ /s)	0
Nominal external pressure (Pa)	0
Maximum external leakage rates (%)	0
Static efficiency (%)	0
Effective electric power input (kW)	0
Sound power level (dB(A))	0
Declared typology	NRVU UVU

Accessories

EC motors regulators

Name	Photo	Description
CDT E/0-10		Speed control for EC motors