

Iso-Mix EC 200 FR1

Sound-insulated inline mixed-flow fans with EC motor



- Maximum airflow: 1040
- Sound pressure level LpA at 3 m: 43
- Sound insulation
- Motor type: EC
- Control: Built-in speed controller
- Impeller type: Mixed-flow
- Casing material: Coated steel
- Installation in any position
- Cable with mains plug

	Unit of measurement	Iso-Mix EC 200 FR1
Connected air duct size	mm	200
Speed	-	1
Minimum supply voltage	V	230
Maximum supply voltage	V	230
Power supply frequency	Hz	50/60
Rated power	W	123
Unit current	A	1.02
Maximum airflow	m ³ /h	1040
Sound pressure level LpA at 3 m	dB(A)	43
Weight	kg	8.6
Transported air temperature (max)	°C	55
Transported air temperature (min)	°C	-25
Ingress protection rating	-	IPX4

Dimensions

ØD	B	B1	L	H
198	343	393	296	558

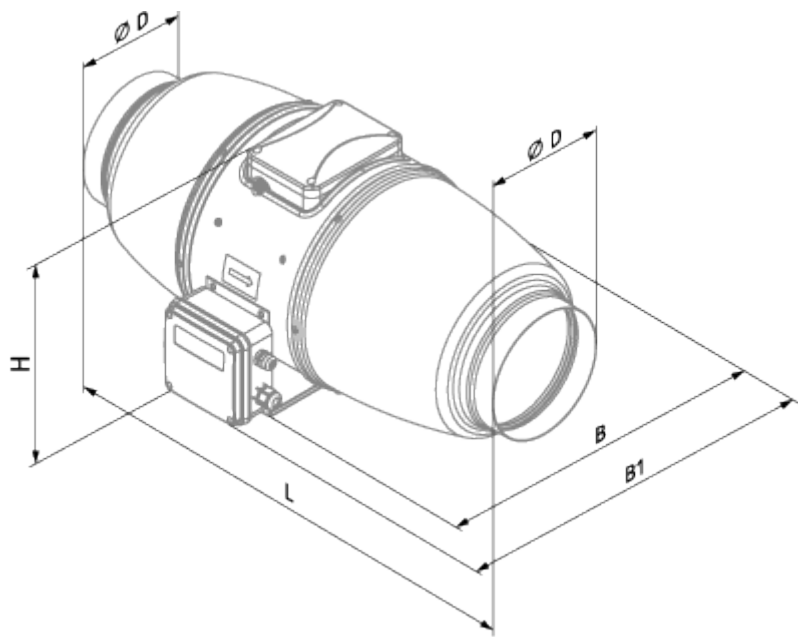

Accessories

EC motors regulators

Name	Photo	Description
CDT E/0-10		Speed control for EC motors