

# Iso-Mix EC 100 FR1

Sound-insulated inline mixed-flow fans with EC motor



- Maximum airflow: 300
- Sound pressure level LpA at 3 m: 37
- Sound insulation
- Motor type: EC
- Control: Built-in speed controller
- Impeller type: Mixed-flow
- Casing material: Coated steel
- Installation in any position
- Cable with mains plug

	Unit of measurement	Iso-Mix EC 100 FR1
Connected air duct size	mm	100
Speed	-	1
Minimum supply voltage	V	230
Maximum supply voltage	V	230
Power supply frequency	Hz	50/60
Rated power	W	30
Unit current	A	0.29
Maximum airflow	m <sup>3</sup> /h	300
Sound pressure level LpA at 3 m	dB(A)	37
Weight	kg	4.9
Transported air temperature (max)	°C	55
Transported air temperature (min)	°C	-25
Ingress protection rating	-	IPX4

## Dimensions

ØD	B	B1	L	H
98	214	243	505	251

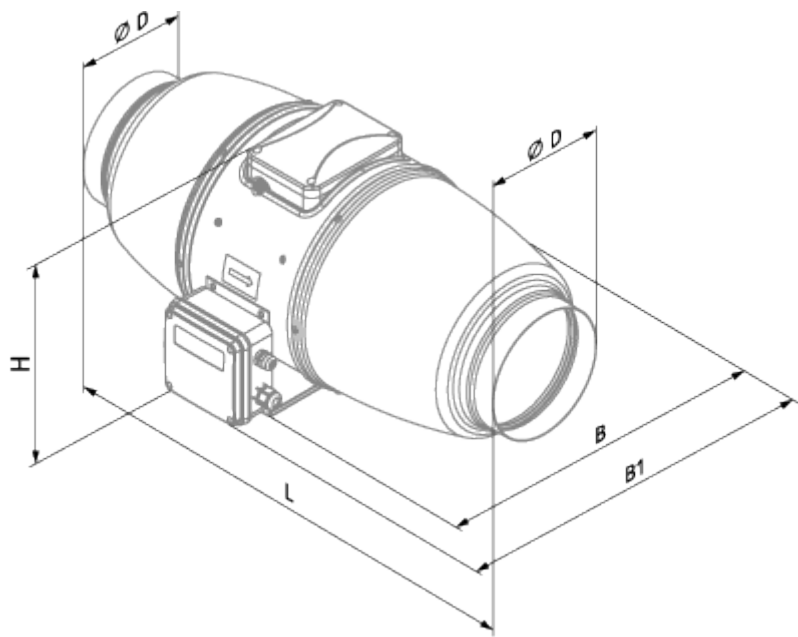

## Accessories

### EC motors regulators

Name	Photo	Description
<a href="#">CDT E/0-10</a>		Speed control for EC motors