

Iso-Mix 250 TUS

Sound-insulated inline mixed-flow fans



- Maximum airflow: 1315
- Sound pressure level LpA at 3 m: 38
- Sound insulation
- Motor type: AC
- Control: Built-in speed controller
- Impeller type: Mixed-flow
- Casing material: Coated steel
- Installation in any position
- Timer: Turn off timer

	Unit of measurement	Iso-Mix 250 TUS	
Connected air duct size	mm	250	
Speed	-	2	
Phases	-	1	
Minimum supply voltage	V	230	
Maximum supply voltage	V	230	
Power supply frequency	Hz	50/60	
Rated power	W	127	178
Unit current	A	0.79	0.52
Maximum airflow	m ³ /h	1035	1315
rotation speed at 50hz	-	1960	2460
Sound pressure level LpA at 3 m	dB(A)	34	38
Weight	kg	15	
Transported air temperature (max)	°C	60	
Ingress protection rating	-	IPX4	
Ingress protection rating of the drive	-	IP44	

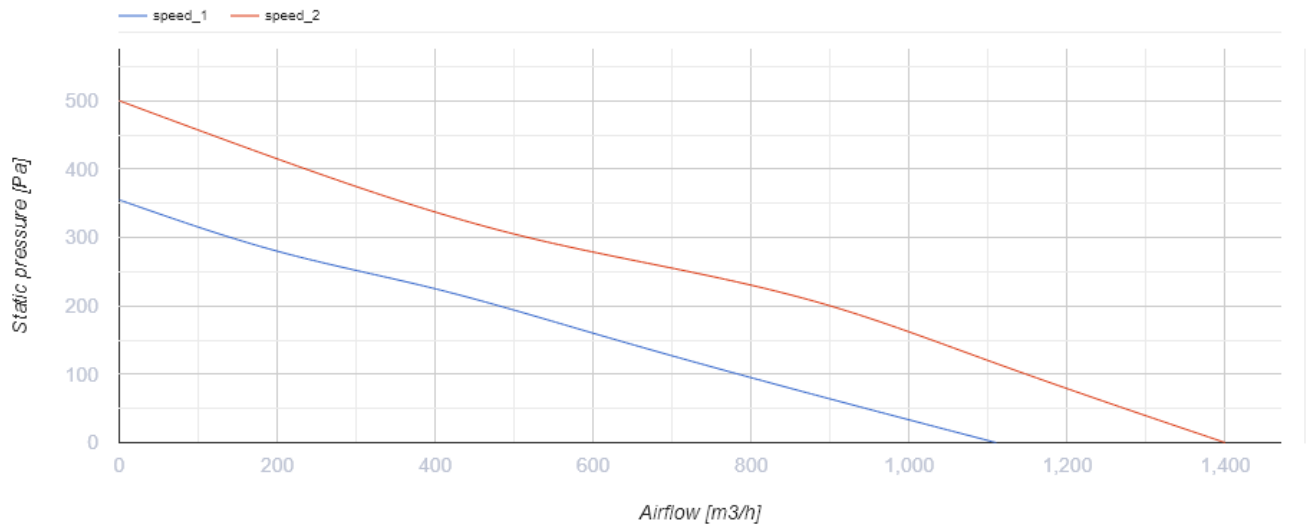

Dimensions

ØD	B	B1	L	H
248	358	445	658	360

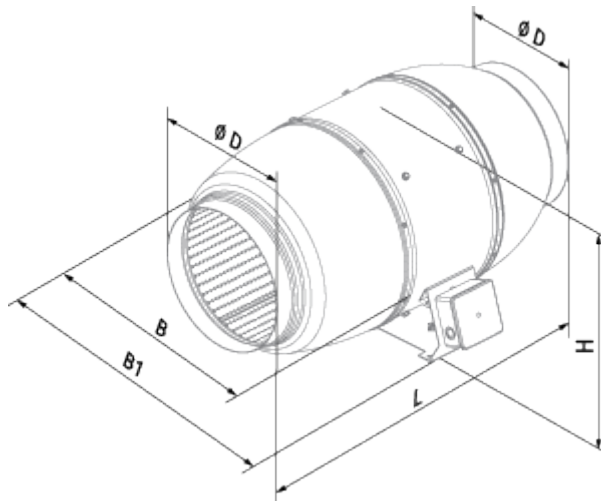



Ecodesign

Trademark	Blauberg
Model	Iso-Mix 250 TUS
Type of ventilation unit	Unidirectional
Type of drive installed	External MSD or VSD
Type of heat recovery system	None
Nominal flow rate (m ³ /s)	0.223
Nominal external pressure (Pa)	236
Maximum external leakage rates (%)	2.7
Static efficiency (%)	30.9
Effective electric power input (kW)	0.174
Sound power level (dB(A))	56
Declared typology	NRVU UVU

Accessories

Speed control switches





Name	Photo	Description
CDP-2/5		Multi-speed switch
CDP-2/10		Multi-speed switch

Thyristor speed controllers



Name	Photo	Description
CDT E1.8		Thyristor speed controller
CDT1 E1.5		Multi-speed switches

Humidity sensors





Name	Photo	Description
------	-------	-------------

TE / TI 1.5		Timers
HSE / HSI 1.5		Sensors
LSE / LSI 1.5		Sensors
IRSE / IRSI 1.5		Sensors

For round ducts







Name	Photo	Description
SD 250/1200		Silencers for round ducts
SD 250/900		Silencers for round ducts
SD 250/600		Silencers for round ducts

For round ducts



Name	Photo	Description
KFBK 250		Filter boxes for round ducts
KFBT 250 G4		Filter boxes with pocket filters for round ducts
KFBT 250 F5		Filter boxes with pocket filters for round ducts
KFBT 250 F7		Filter boxes with pocket filters for round ducts

Electrical heaters

Name	Photo	Description
------	-------	-------------

EKH 250-1.2		Duct electrical heaters for round ducts
EKH 250-2.0		Duct electrical heaters for round ducts
EKH 250-2.4		Duct electrical heaters for round ducts
EKH 250-3.0		Duct electrical heaters for round ducts
EKH 250-3.6		Duct electrical heaters for round ducts
EKH 250-6.0		Duct electrical heaters for round ducts
EKH 250-9.0		Duct electrical heaters for round ducts

Water heaters

Name	Photo	Description
WKH 250-2		Duct water heaters for round ducts
WKH 250-4		Duct water heaters for round ducts

For round ducts

Name	Photo	Description
VRV 250		Backdraft dampers with spring for round ducts
VKA 250		Air dampers for round ducts