

Iso-Mix 250 G1

Mixed-flow inline fans in sound-insulated casings



- Maximum airflow: 1315
- Sound pressure level LpA at 3 m: 38
- Sound insulation
- Motor type: AC
- Control: Built-in speed controller
- Impeller type: Mixed-flow
- Casing material: Coated steel
- Installation in any position
- Cable with mains plug
- Temperature sensor

	Unit of measurement	Iso-Mix 250 G1	
Connected air duct size	mm	250	
Speed	-	2	
Phases	-	1	
Minimum supply voltage	V	230	
Maximum supply voltage	V	230	
Power supply frequency	Hz	50/60	
Rated power	W	127	178
Unit current	A	0.79	0.52
Maximum airflow	m ³ /h	1035	1315
rotation speed at 50hz	-	1960	2460
Sound pressure level LpA at 3 m	dB(A)	34	38
Weight	kg	15	
Transported air temperature (max)	°C	60	
Ingress protection rating	-	IPX4	
Ingress protection rating of the drive	-	IP44	

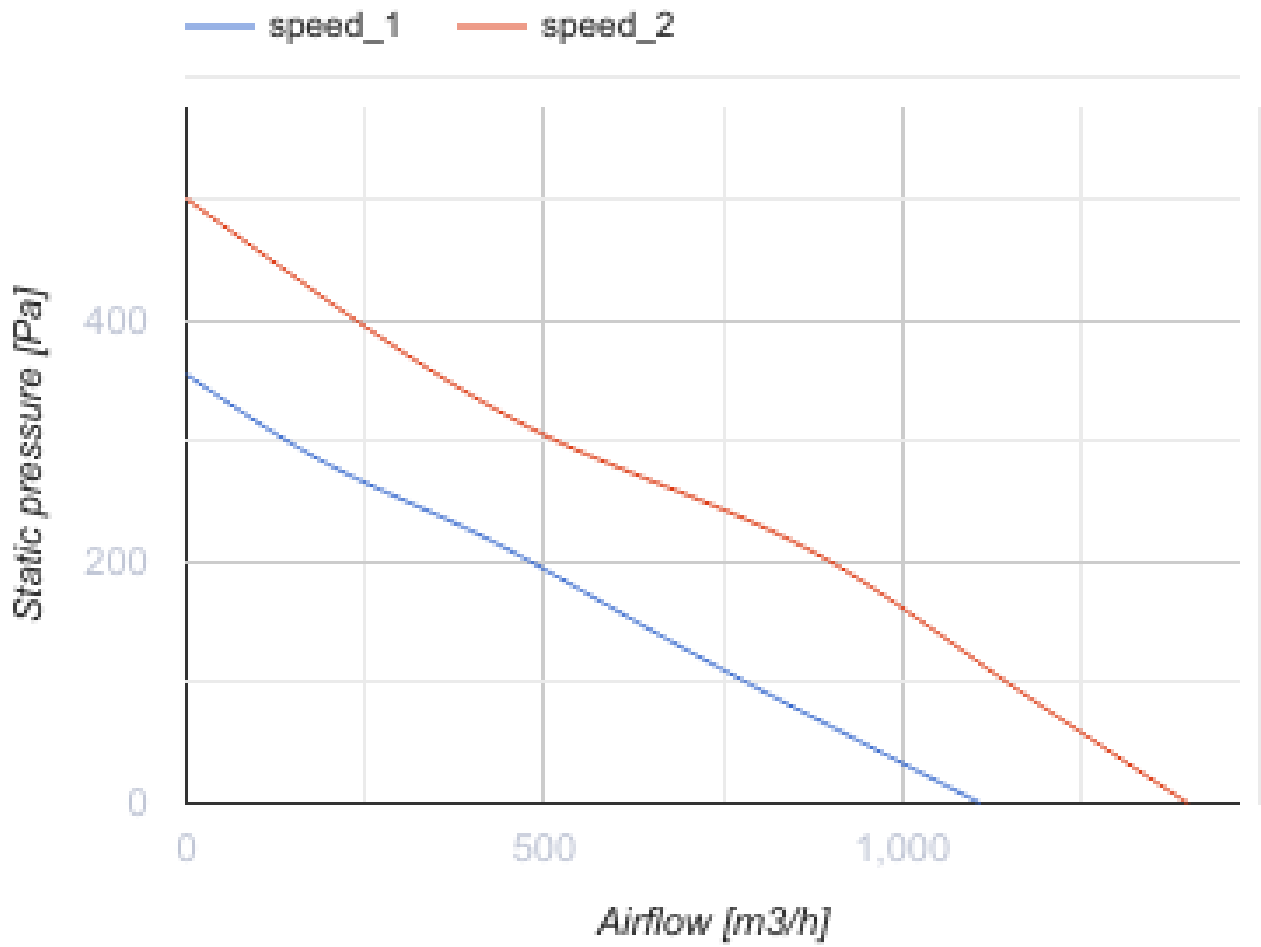

Dimensions

ØD	B	B1	L	H
248	358	445	658	360

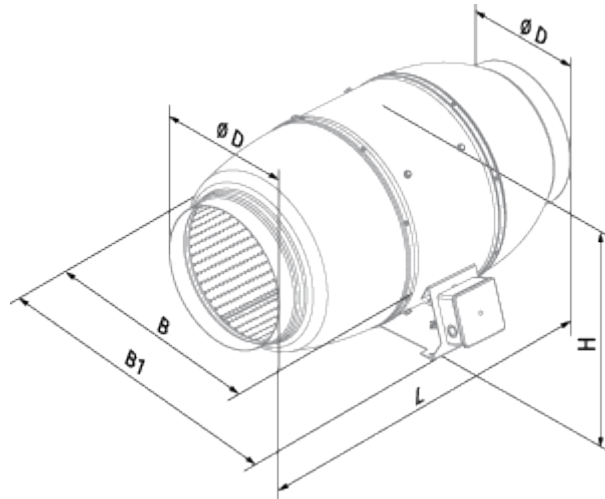





Ecodesign

Trademark	Blauberg
Model	Iso-Mix 250 G1
Type of ventilation unit	Unidirectional
Type of drive installed	External MSD or VSD
Type of heat recovery system	None
Nominal flow rate (m ³ /s)	0.223
Nominal external pressure (Pa)	236
Maximum external leakage rates (%)	2.7
Static efficiency (%)	30.9
Declared typology	NRVU UVU
Effective electric power input (kW)	0.174
Sound power level (dB(A))	56



Accessories

Other accessories



Name	Photo	Description
CDP-2/5		Multi-speed switch
CDT E1.8		Thyristor speed controller
CDP-2/10		Multi-speed switch
CDT1 E1.5		Multi-speed switches

Other accessories





Name	Photo	Description
TE / TI 1.5		Timers

HSE / HSI 1.5		Sensors
LSE / LSI 1.5		Sensors
IRSE / IRSI 1.5		Sensors

Other accessories









Name	Photo	Description
SD 250/1200		Silencers for round ducts
SD 250/900		Silencers for round ducts
SD 250/600		Silencers for round ducts

Other accessories

Name	Photo	Description
KFBK 250		Filter boxes for round ducts
KFBT 250 G4		Filter boxes with pocket filters for round ducts
KFBT 250 F5		Filter boxes with pocket filters for round ducts
KFBT 250 F7		Filter boxes with pocket filters for round ducts

Other accessories

Name	Photo	Description
EKH 250-1.2		Duct electrical heaters for round ducts

EKH 250-2.0		Duct electrical heaters for round ducts
EKH 250-2.4		Duct electrical heaters for round ducts
EKH 250-3.0		Duct electrical heaters for round ducts
EKH 250-3.6		Duct electrical heaters for round ducts
EKH 250-6.0		Duct electrical heaters for round ducts
EKH 250-9.0		Duct electrical heaters for round ducts
WKH 250-2		Duct water heaters for round ducts
WKH 250-4		Duct water heaters for round ducts

Other accessories

Name	Photo	Description
VRV 250		Backdraft dampers with spring for round ducts
VKA 250		Air dampers for round ducts