

Iso-Mix 200 T

Sound-insulated inline mixed-flow fans



- Maximum airflow: 1035
- Sound pressure level LpA at 3 m: 36
- Sound insulation
- Motor type: AC
- Impeller type: Mixed-flow
- Casing material: Coated steel
- Installation in any position
- Timer: Turn off timer

	Unit of measurement	Iso-Mix 200 T		
Connected air duct size	mm	200		
Speed	-	3		
Phases	-	1		
Minimum supply voltage	V	230		
Maximum supply voltage	V	230		
Power supply frequency	Hz	50/60		
Rated power	W	82	100	110
Unit current	A	0.37	0.44	0.49
Maximum airflow	m ³ /h	731	961	1035
rotation speed at 50hz	-	2376	2382	2445
Sound pressure level LpA at 3 m	dB(A)	30	34	36
Weight	kg	8		
Transported air temperature (max)	°C	60		
Ingress protection rating	-	IPX4		
Ingress protection rating of the drive	-	IP44		

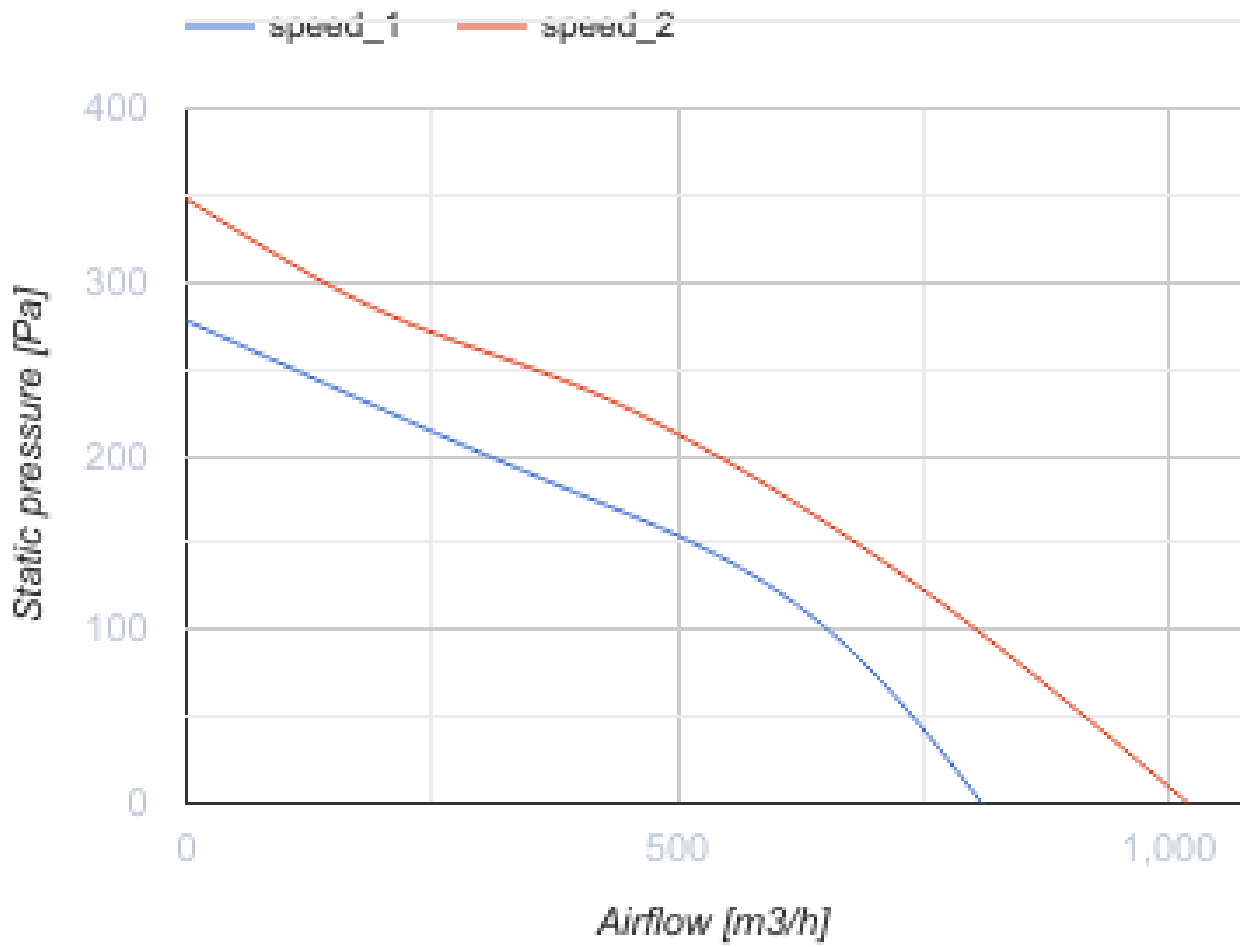

Dimensions

ØD	B	B1	L	H
198	293	386	550	295

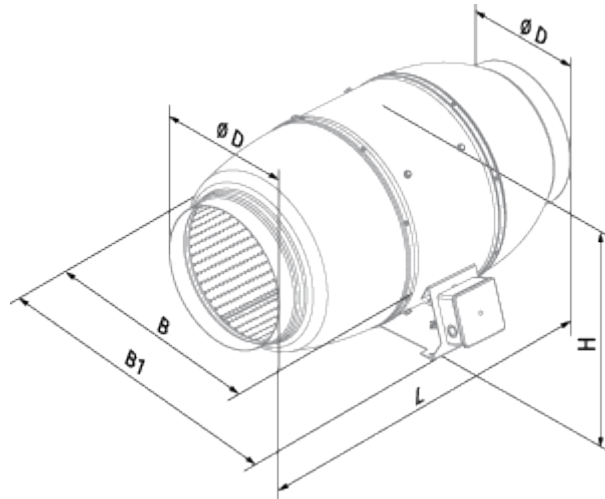

Ecodesign

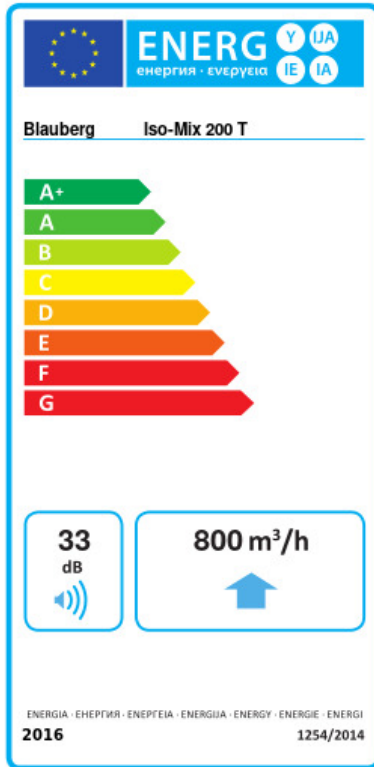

Trademark	Blaubeerg					
Model	Iso-Mix 200 T					
Specific energy consumption (SEC) (kWh/(m ² /a))	Cold	Average	Warm			
	-32.6	B	-14.6	E	-4.4	F
Type of ventilation unit	Unidirectional					
Type of drive installed	Multi-speed					
Type of heat recovery system	None					
Maximum flow rate (m ³ /h)	800					
Electric power input (W)	110					
Reference flow rate (m ³ /s)	0.156					
Reference pressure difference (Pa)	50					
Specific power input (SPI) (W/(m ³ /h))	0.139					
Control typology	Clock control					
Maximum external leakage rates (%)	2.7					
Declared typology	RVU UVU					
Sound power level (dB(A))	33					
The annual electricity consumption (AEC) (kWh/a)	Cold	Average	Warm			
	164	164	164			
The annual heating saved (AHS) (kWh/a)	Cold	Average	Warm			
	3667	1874	848			



Accessories

Speed control switches





Name	Photo	Description
CDP-2/5		Multi-speed switch
CDP-2/10		Multi-speed switch

Thyristor speed controllers





Name	Photo	Description
------	-------	-------------

CDT E1.8		Thyristor speed controller
CDT1 E0.5		Multi-speed switches

Humidity sensors

Name	Photo	Description
TE / TI 1.5		Timers
HSE / HSI 1.5		Sensors
LSE / LSI 1.5		Sensors
IRSE / IRSI 1.5		Sensors

For round ducts









Name	Photo	Description
KFBT 200 G4		Filter boxes with pocket filters for round ducts
KFBK 200		Filter boxes for round ducts
KFBT 200 F5		Filter boxes with pocket filters for round ducts
KFBT 200 F7		Filter boxes with pocket filters for round ducts

For round ducts



Name	Photo	Description
SD 200/1200		Silencers for round ducts

SD 200/900		Silencers for round ducts
SD 200/600		Silencers for round ducts

Electrical heaters

Name	Photo	Description
EKH 200-1.2		Duct electrical heaters for round ducts
EKH 200-1.7		Duct electrical heaters for round ducts
EKH 200-2.0		Duct electrical heaters for round ducts
EKH 200-2.4		Duct electrical heaters for round ducts
EKH 200-3.4		Duct electrical heaters for round ducts
EKH 200-3.6		Duct electrical heaters for round ducts
EKH 200-5.1		Duct electrical heaters for round ducts
EKH 200-6.0		Duct electrical heaters for round ducts

Water heaters

Name	Photo	Description
WKH 200-2		Duct water heaters for round ducts
WKH 200-4		Duct water heaters for round ducts

For round ducts

Name	Photo	Description
VRV 200		Backdraft dampers with spring for round ducts
VKA 200		Air dampers for round ducts