

Iso-Mix 150 TW1

Sound-insulated inline mixed-flow fans



- Maximum airflow: 550
- Sound pressure level LpA at 3 m: 33
- Sound insulation
- Motor type: AC
- Impeller type: Mixed-flow
- Casing material: Coated steel
- Installation in any position
- Cable with mains plug
- Timer: Turn off timer

	Unit of measurement	Iso-Mix 150 TW1	
Connected air duct size	mm	150	
Speed	-	2	
Phases	-	1	
Minimum supply voltage	V	230	
Maximum supply voltage	V	230	
Power supply frequency	Hz	50/60	
Rated power	W	45	52
Unit current	A	0.2	0.23
Maximum airflow	m ³ /h	410	550
rotation speed at 50hz	-	1985	2640
Sound pressure level LpA at 3 m	dB(A)	26	33
Weight	kg	6.1	
Transported air temperature (max)	°C	60	
Ingress protection rating	-	IPX4	
Ingress protection rating of the drive	-	IP44	

Dimensions

$\varnothing D$	B	B1	L	H
148	247	273	579	263

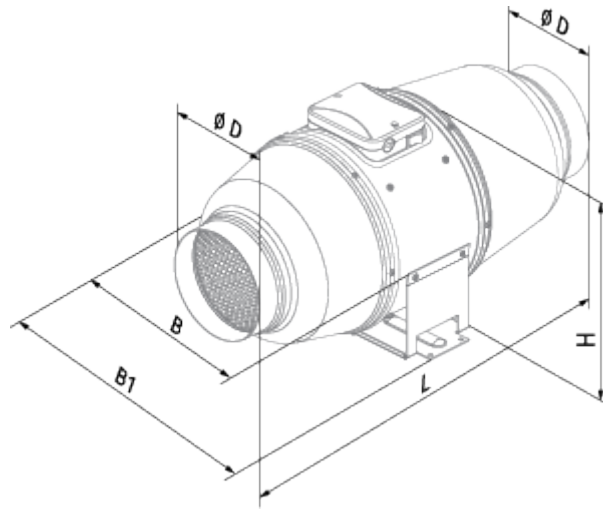



Ecodesign



Trademark	Blauberg					
Model	Iso-Mix 150 TW1					
Specific energy consumption (SEC) (kWh/(m ² /a))	Cold		Average		Warm	
	52.8	A+	25.7	C	10.2	E
Type of ventilation unit	Unidirectional					
Type of drive installed	Multi-speed					
Type of heat recovery system	None					
Maximum flow rate (m ³ /h)	470					
Electric power input (W)	52					
Reference flow rate (m ³ /s)	0.091					
Reference pressure difference (Pa)	50					
Specific power input (SPI) (W/(m ³ /h))	0.137					
Control typology	Local demand control					
Maximum external leakage rates (%)	2.7					
Sound power level (dB(A))	33					
Declared typology	RVU UVU					
The annual electricity consumption (AEC) (kWh/a)	Cold		Average		Warm	
	102		102		102	
The annual heating saved (AHS) (kWh/a)	Cold		Average		Warm	
	5536		2830		1280	

Accessories

Speed control switches





Name	Photo	Description
CDP-2/5		Multi-speed switch
CDP-2/10		Multi-speed switch

Thyristor speed controllers





Name	Photo	Description
------	-------	-------------

CDT E0.5		Thyristor speed controller
CDT E1.8		Thyristor speed controller

Humidity sensors



Name	Photo	Description
TE / TI 1.5		Timers
HSE / HSI 1.5		Sensors
LSE / LSI 1.5		Sensors
IRSE / IRSI 1.5		Sensors

For round ducts









Name	Photo	Description
KFBT 150 G4		Filter boxes with pocket filters for round ducts
KFBK 150		Filter boxes for round ducts
KFBT 150 F5		Filter boxes with pocket filters for round ducts
KFBT 150 F7		Filter boxes with pocket filters for round ducts

For round ducts



Name	Photo	Description
SD 150/1200		Silencers for round ducts

SD 150/900		Silencers for round ducts
SD 150/600		Silencers for round ducts

Electrical heaters

Name	Photo	Description
EKH 150-1.2		Duct electrical heaters for round ducts
EKH 150-1.7		Duct electrical heaters for round ducts
EKH 150-2.0		Duct electrical heaters for round ducts
EKH 150-2.4		Duct electrical heaters for round ducts
EKH 150-3.4		Duct electrical heaters for round ducts
EKH 150-3.6		Duct electrical heaters for round ducts
EKH 150-5.1		Duct electrical heaters for round ducts
EKH 150-6.0		Duct electrical heaters for round ducts

Water heaters

Name	Photo	Description
WKH 150-2		Duct water heaters for round ducts
WKH 150-4		Duct water heaters for round ducts

For round ducts

Name	Photo	Description
VRV 150		Backdraft dampers with spring for round ducts
VKA 150		Air dampers for round ducts