

Iso-Mix 150 FR1

Mixed-flow inline fans in sound-insulated casings



- Maximum airflow: 550
- Sound pressure level LpA at 3 m: 33
- Sound insulation
- Motor type: AC
- Control: Built-in speed controller
- Impeller type: Mixed-flow
- Casing material: Coated steel
- Installation in any position
- Cable with mains plug

	Unit of measurement	Iso-Mix 150 FR1	
Connected air duct size	mm	150	
Speed	-	2	
Phases	-	1	
Minimum supply voltage	V	230	
Maximum supply voltage	V	230	
Power supply frequency	Hz	50/60	
Rated power	W	45	52
Unit current	A	0.2	0.23
Maximum airflow	m ³ /h	410	550
rotation speed at 50hz	-	1985	2640
Sound pressure level LpA at 3 m	dB(A)	26	33
Weight	kg	6.1	
Transported air temperature (max)	°C	60	
Ingress protection rating	-	IPX4	
Ingress protection rating of the drive	-	IP44	

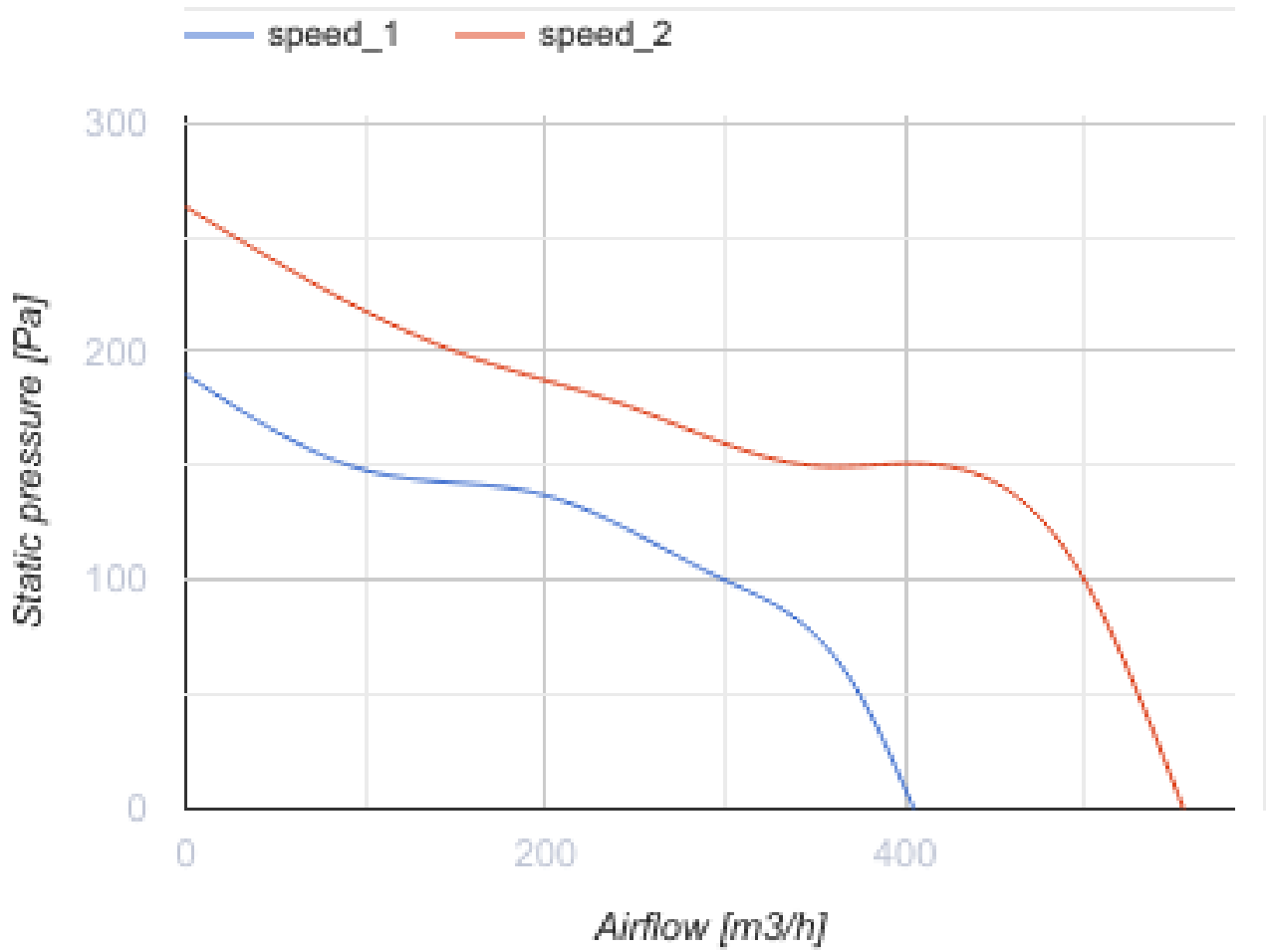

Dimensions

ØD	B	B1	L	H
148	148	273	579	263

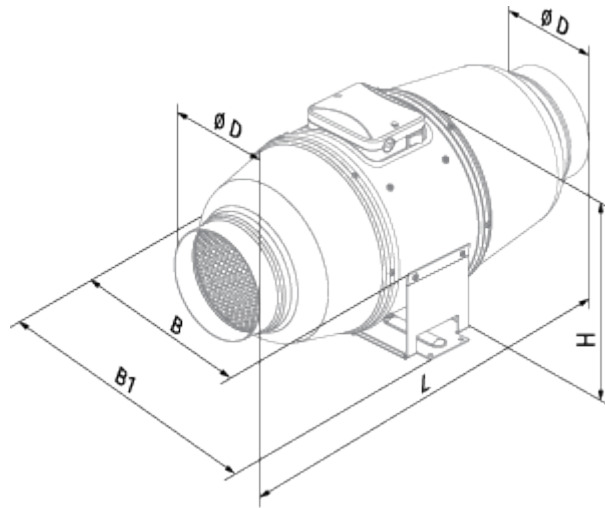



Ecodesign



Trademark	Blauberg					
Model	Iso-Mix 150 FR1					
Specific energy consumption (SEC) (kWh/(m ² /a))	Cold		Average		Warm	
	52.8	A+	25.7	C	10.2	E
Type of ventilation unit	Unidirectional					
Type of drive installed	Multi-speed					
Type of heat recovery system	None					
Maximum flow rate (m ³ /h)	470					
Electric power input (W)	52					
Reference flow rate (m ³ /s)	0.091					
Reference pressure difference (Pa)	50					
Specific power input (SPI) (W/(m ³ /h))	0.137					
Control typology	Local demand control					
Maximum external leakage rates (%)	2.7					
Declared typology	RVU UVU					
Sound power level (dB(A))	33					
The annual electricity consumption (AEC) (kWh/a)	Cold		Average		Warm	
	102		102		102	
The annual heating saved (AHS) (kWh/a)	Cold		Average		Warm	
	5536		2830		1280	





Accessories

Other accessories





Name	Photo	Description
CDP-2/5		Multi-speed switch
CDT E1.8		Thyristor speed controller
CDP-2/10		Multi-speed switch

CDT1 E0.5		Multi-speed switches
---------------------------	---	----------------------



Other accessories

Name	Photo	Description
TE / TI 1.5		Timers
HSE / HSI 1.5		Sensors
LSE / LSI 1.5		Sensors
IRSE / IRSI 1.5		Sensors

Other accessories











Name	Photo	Description
KFBT 150 G4		Filter boxes with pocket filters for round ducts
KFBK 150		Filter boxes for round ducts
KFBT 150 F5		Filter boxes with pocket filters for round ducts
KFBT 150 F7		Filter boxes with pocket filters for round ducts

Other accessories

Name	Photo	Description
SD 150/1200		Silencers for round ducts
SD 150/900		Silencers for round ducts

SD 150/600		Silencers for round ducts
----------------------------	---	---------------------------

Other accessories

Name	Photo	Description
EKH 150-1.2		Duct electrical heaters for round ducts
EKH 150-1.7		Duct electrical heaters for round ducts
EKH 150-2.0		Duct electrical heaters for round ducts
EKH 150-2.4		Duct electrical heaters for round ducts
EKH 150-3.4		Duct electrical heaters for round ducts
EKH 150-3.6		Duct electrical heaters for round ducts
EKH 150-5.1		Duct electrical heaters for round ducts
EKH 150-6.0		Duct electrical heaters for round ducts
WKH 150-2		Duct water heaters for round ducts
WKH 150-4		Duct water heaters for round ducts

Other accessories

Name	Photo	Description
VRV 150		Backdraft dampers with spring for round ducts

[VKA 150](#)



Air dampers for round ducts