

# Iso-Mix 125 TUSW1

Mixed-flow inline fans in sound-insulated casings



- Maximum airflow: 347
- Sound pressure level LpA at 3 m: 28
- Sound insulation
- Motor type: AC
- Control: Built-in speed controller
- Impeller type: Mixed-flow
- Casing material: Coated steel
- Installation in any position
- Cable with mains plug
- Timer: Turn off timer

	Unit of measurement	Iso-Mix 125 TUSW1	
Connected air duct size	mm	125	
Speed	-	2	
Phases	-	1	
Minimum supply voltage	V	230	
Maximum supply voltage	V	230	
Power supply frequency	Hz	50/60	
Rated power	W	25	29
Unit current	A	0.11	0.13
Maximum airflow	m <sup>3</sup> /h	235	347
rotation speed at 50hz	-	1660	2315
Sound pressure level LpA at 3 m	dB(A)	23	28
Weight	kg	4.6	
Transported air temperature (max)	°C	60	
Ingress protection rating	-	IPX4	
Ingress protection rating of the drive	-	IP44	

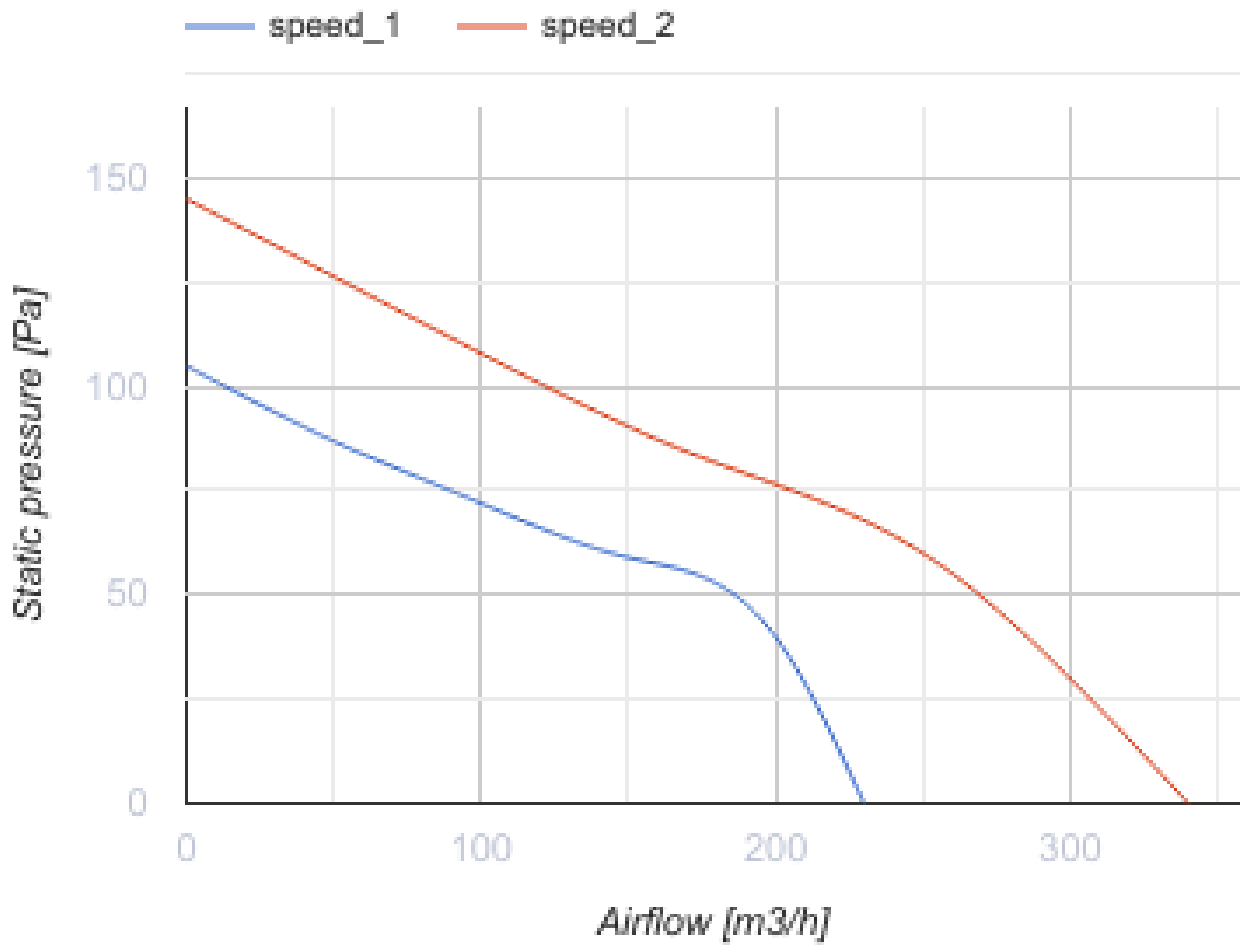

### Dimensions

ØD	B	B1	L	H
123	214	243	474	251

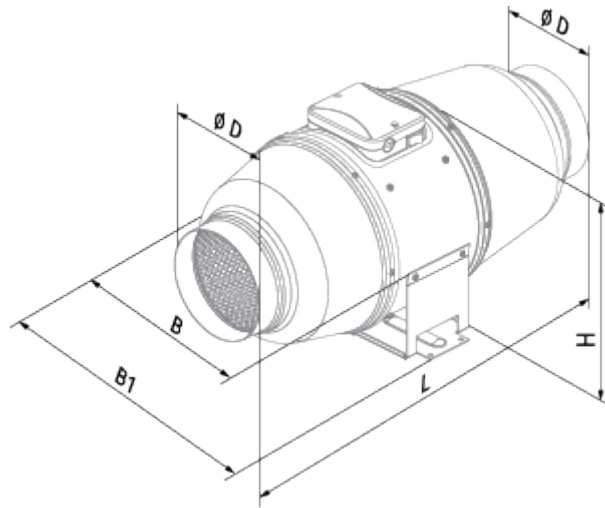



## Ecodesign



Trademark	Blauberg					
Model	Iso-Mix 125 TUSW1					
Specific energy consumption (SEC) (kWh/(m <sup>2</sup> /a))	Cold		Average		Warm	
	50	A+	23	D	7.5	F
Type of ventilation unit	Unidirectional					
Type of drive installed	Multi-speed					
Type of heat recovery system	None					
Maximum flow rate (m <sup>3</sup> /h)	125					
Electric power input (W)	29					
Reference flow rate (m <sup>3</sup> /s)	0.024					
Reference pressure difference (Pa)	50					
Specific power input (SPI) (W/(m <sup>3</sup> /h))	0.286					
Control typology	Local demand control					
Maximum external leakage rates (%)	2.7					
Declared typology	RVU UVU					
Sound power level (dB(A))	28					
The annual electricity consumption (AEC) (kWh/a)	Cold		Average		Warm	
	213		213		213	
The annual heating saved (AHS) (kWh/a)	Cold		Average		Warm	
	5536		2830		1280	





## Accessories

### Other accessories







Name	Photo	Description
<a href="#">CDP-2/5</a>		Multi-speed switch
<a href="#">CDT E1.8</a>		Thyristor speed controller
<a href="#">CDP-2/10</a>		Multi-speed switch

<a href="#">CDT1 E0.5</a>		Multi-speed switches
---------------------------	---	----------------------





### Other accessories

Name	Photo	Description
<a href="#">TE / TI 1.5</a>		Timers
<a href="#">HSE / HSI 1.5</a>		Sensors
<a href="#">LSE / LSI 1.5</a>		Sensors
<a href="#">IRSE / IRSI 1.5</a>		Sensors



### Other accessories

Name	Photo	Description
<a href="#">EKH 125-0.8</a>		Duct electrical heaters for round ducts
<a href="#">EKH 125-0.6</a>		Duct electrical heaters for round ducts
<a href="#">EKH 125-1.2</a>		Duct electrical heaters for round ducts
<a href="#">EKH 125-1.6</a>		Duct electrical heaters for round ducts
<a href="#">EKH 125-2.4</a>		Duct electrical heaters for round ducts
<a href="#">WKH 125-2</a>		Duct water heaters for round ducts
<a href="#">WKH 125-4</a>		Duct water heaters for round ducts

### Other accessories

Name	Photo	Description
<a href="#">KFBT 125 F7</a>		Filter boxes with pocket filters for round ducts
<a href="#">KFBT 125 F5</a>		Filter boxes with pocket filters for round ducts
<a href="#">KFBT 125 G4</a>		Filter boxes with pocket filters for round ducts
<a href="#">KFBK 125</a>		Filter boxes for round ducts

#### Other accessories

Name	Photo	Description
<a href="#">SD 125/1200</a>		Silencers for round ducts
<a href="#">SD 125/900</a>		Silencers for round ducts
<a href="#">SD 125/600</a>		Silencers for round ducts

#### Other accessories

Name	Photo	Description
<a href="#">VRV 125</a>		Backdraft dampers with spring for round ducts
<a href="#">VKA 125</a>		Air dampers for round ducts