

Iso-Mix 125 FR1

Sound-insulated inline mixed-flow fans



- Maximum airflow: 347
- Sound pressure level LpA at 3 m: 28
- Sound insulation
- Motor type: AC
- Control: Built-in speed controller
- Impeller type: Mixed-flow
- Casing material: Coated steel
- Installation in any position
- Cable with mains plug

| | Unit of measurement | Iso-Mix 125 FR1 | |
|--|---------------------|-----------------|------|
| Connected air duct size | mm | 125 | |
| Speed | - | 2 | |
| Phases | - | 1 | |
| Minimum supply voltage | V | 230 | |
| Maximum supply voltage | V | 230 | |
| Power supply frequency | Hz | 50/60 | |
| Rated power | W | 25 | 29 |
| Unit current | A | 0.11 | 0.13 |
| Maximum airflow | m ³ /h | 235 | 347 |
| rotation speed at 50hz | - | 1660 | 2315 |
| Sound pressure level LpA at 3 m | dB(A) | 23 | 28 |
| Weight | kg | 4.6 | |
| Transported air temperature (max) | °C | 60 | |
| Ingress protection rating | - | IPX4 | |
| Ingress protection rating of the drive | - | IP44 | |

Dimensions

| $\varnothing D$ | B | B1 | L | H |
|-----------------|-----|-----|-----|-----|
| 123 | 214 | 243 | 474 | 251 |

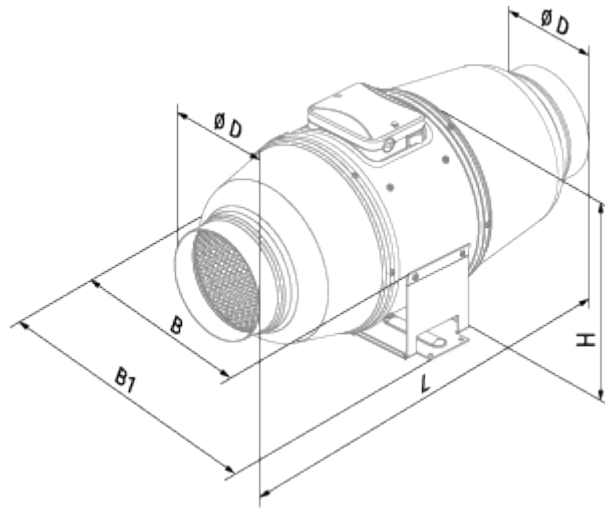



Ecodesign



| | | | | | | |
|---|----------------------|----|---------|---|------|---|
| Trademark | Blauberg | | | | | |
| Model | Iso-Mix 125 FR1 | | | | | |
| Specific energy consumption (SEC) (kWh/(m ² /a)) | Cold | | Average | | Warm | |
| | 50 | A+ | 23 | D | 7.5 | F |
| Type of ventilation unit | Unidirectional | | | | | |
| Type of drive installed | Multi-speed | | | | | |
| Type of heat recovery system | None | | | | | |
| Maximum flow rate (m ³ /h) | 125 | | | | | |
| Electric power input (W) | 29 | | | | | |
| Reference flow rate (m ³ /s) | 0.024 | | | | | |
| Reference pressure difference (Pa) | 50 | | | | | |
| Specific power input (SPI) (W/(m ³ /h)) | 0.286 | | | | | |
| Control typology | Local demand control | | | | | |
| Maximum external leakage rates (%) | 2.7 | | | | | |
| Sound power level (dB(A)) | 28 | | | | | |
| Declared typology | RVU UVU | | | | | |
| The annual electricity consumption (AEC) (kWh/a) | Cold | | Average | | Warm | |
| | 213 | | 213 | | 213 | |
| The annual heating saved (AHS) (kWh/a) | Cold | | Average | | Warm | |
| | 5536 | | 2830 | | 1280 | |

Accessories

Speed control switches





| Name | Photo | Description |
|--------------------------|---|--------------------|
| CDP-2/5 |  | Multi-speed switch |
| CDP-2/10 |  | Multi-speed switch |

Thyristor speed controllers





| Name | Photo | Description |
|------|-------|-------------|
|------|-------|-------------|

| | | |
|---------------------------|---|----------------------------|
| CDT E1.8 |  | Thyristor speed controller |
| CDT1 E0.5 |  | Multi-speed switches |

Humidity sensors





| Name | Photo | Description |
|---------------------------------|--|-------------|
| TE / TI 1.5 |  | Timers |
| HSE / HSI 1.5 |  | Sensors |
| LSE / LSI 1.5 |  | Sensors |
| IRSE / IRSI 1.5 |  | Sensors |

Electrical heaters



| Name | Photo | Description |
|-----------------------------|---|---|
| EKH 125-0.8 |  | Duct electrical heaters for round ducts |
| EKH 125-0.6 |  | Duct electrical heaters for round ducts |
| EKH 125-1.2 |  | Duct electrical heaters for round ducts |
| EKH 125-1.6 |  | Duct electrical heaters for round ducts |
| EKH 125-2.4 |  | Duct electrical heaters for round ducts |

For round ducts



| Name | Photo | Description |
|------|-------|-------------|
|------|-------|-------------|

| | | |
|-----------------------------|---|--|
| KFBT 125 F7 |  | Filter boxes with pocket filters for round ducts |
| KFBT 125 F5 |  | Filter boxes with pocket filters for round ducts |
| KFBT 125 G4 |  | Filter boxes with pocket filters for round ducts |
| KFBK 125 |  | Filter boxes for round ducts |



For round ducts

| Name | Photo | Description |
|-----------------------------|---|---------------------------|
| SD 125/1200 |  | Silencers for round ducts |
| SD 125/900 |  | Silencers for round ducts |
| SD 125/600 |  | Silencers for round ducts |

Water heaters

| Name | Photo | Description |
|---------------------------|---|------------------------------------|
| WKH 125-2 |  | Duct water heaters for round ducts |
| WKH 125-4 |  | Duct water heaters for round ducts |

For round ducts

| Name | Photo | Description |
|-------------------------|---|---|
| VRV 150 |  | Backdraft dampers with spring for round ducts |
| VKA 150 |  | Air dampers for round ducts |